

airmaster



50L OIL FREE AIR COMPRESSOR MODEL NO: TIGER 16/550

PART NO: 1499510

OPERATION & MAINTENANCE INSTRUCTIONS



ORIGINAL INSTRUCTIONS

GC1120 - ISS 2

INTRODUCTION

Thank you for purchasing this Air Compressor.

Before attempting to operate the machine, it is essential that you read this manual thoroughly and carefully follow all instructions given. In doing so you will ensure the safety of yourself and that of others around you, and you can also look forward to the product giving you long and satisfactory service

TECHNICAL DATA

Power supply	230 V/ 50 Hz
Dimensions (L x W x H)	710 x 360 x 650 mm
Weight	38.5 kg
Receiver capacity	50L
Fuse rating	13 amps
Max working pressure	8 Bar/116 psi
Max flow rate	14.5 cu.ft/min)
Sound power level	97 dB LwA

Please note that the details and specifications contained herein, are correct at the time of going to print.

GUARANTEE

This product is guaranteed against faulty manufacture for a period of 12 months from the date of purchase. Please keep your receipt as proof of purchase.

This guarantee is invalid if the product is found to have been abused or tampered with in any way, or not used for the purpose for which it was intended.

Faulty goods should be returned to their place of purchase, no product can be returned to us without prior permission. This guarantee does not effect your statutory rights.

PARTS AND SERVICING

PARTS	0871 410 1270
SERVICE	0871 410 1290
CUSTOMER CARE	0115 840 6235

GENERAL SAFETY WARNINGS



WARNING: WHEN USING ELECTRICAL TOOLS, BASIC SAFETY PRECAUTIONS SHOULD ALWAYS BE FOLLOWED TO REDUCE THE RISK OF FIRE, ELECTRIC SHOCK AND PERSONAL INJURY

WARNING: READ ALL THESE INSTRUCTIONS BEFORE ATTEMPTING TO OPERATE THIS PRODUCT AND KEEP THESE INSTRUCTIONS IN A SAFE PLACE.

WORK AREA

1. **Keep the work area clean and well lit.** Floors should always be kept clear. Cluttered or dark areas invite accidents.
2. **Keep children and bystanders away while operating a power tool.** Distractions can cause loss of control.
3. The compressor should only be used in areas with adequate ventilation and should not be exposed to heat or used near flammable substances

PERSONAL SAFETY

1. **ALWAYS** stay alert, watch what you are doing and use common sense when operating the compressor. Do not use the compressor while you are tired or under the influence of medication, drugs or alcohol. A moment of inattention can result in personal injury.
2. **ALWAYS** use eye protection when operating compressed air equipment, and ensure that others in the work area are protected from flying particles from the front and from the side.
3. **ALWAYS** protect yourself against electric shock. Never operate the compressor in wet or damp locations.
4. **NEVER** over-reach. Keep your proper footing and balance at all times to enable better control of the compressor in unexpected situations.
5. **NEVER** attempt any complex repairs yourself. If you have a technical problem contact your local dealer.
6. **ALWAYS** store the compressor out of reach of children.
7. **ALWAYS** protect your hearing. Ear protection should be worn when operating this compressor and it's associated power tools.
8. **NEVER** direct the air stream at people or animals, as injury may result. Compressed air can cause soft tissue damage and propel dirt and other particles at high speed.
9. **NEVER** insert your fingers or other objects inside the motor housing. Never operate the compressor without the cover in place.

GENERAL MACHINE USE AND CARE

1. Prior to use, all operators should become familiar with the instructions in this booklet especially the ON/OFF switch for emergency stopping.
2. **ALWAYS** maintain the compressor with care and keep it clean for best / safest performance.
3. **NEVER** use this compressor if any part is damaged. Have it inspected and repaired by your dealer.
4. **NEVER** attempt to modify the air compressor, tank, fittings or attachments in any way. Doing so will invalidate the guarantee and could result in personal injury.
5. **NEVER** abuse the power cable. Never pull on the cable when removing the plug from the socket, or lift the compressor by the power cable.
6. **ONLY** use extension leads that are of an appropriate power rating and suitable for the work environment. Extension leads must have an earth connection. Inspect the extension lead regularly and replace if damaged.
7. **ONLY USE RECOMMENDED PARTS:** To avoid the risk of bursting, only hoses with a rated pressure of 10 bar, or more should be used. Never attempt to repair damaged hoses.
8. **NEVER** abuse the compressor by standing on it.

AIRLINE HOSES







1. **ALWAYS** ensure that equipment or power tools used in conjunction with the compressor have a safe working pressure exceeding that of the machine.
2. **ALWAYS** keep the air hose away from any attached power tools and ensure that the operator is not restricted by the length of the hose.
3. **ALWAYS** take care when a long air hose is required in the work area as it presents a trip hazard. Coil the hose away as soon as the job is finished.
4. **ALWAYS** avoid kinking or trapping the air hose. Always replace faulty hoses and never attempt a repair if a leak is detected.
5. **NEVER** abuse hoses or connectors. NEVER carry an air tool by the hose, or yank it to disconnect from the air supply. Keep hoses away from heat, oil and sharp edges. Check hoses for leaks or worn condition before use and ensure that all connections are secure.
6. **ALWAYS** ensure that the air supply is turned off at the machine outlet and any air pressure vented from within the compressor and any attached equipment when disconnecting air hoses or other equipment.

AIR COMPRESSOR SAFETY INSTRUCTIONS

1. **ONLY USE WITHIN THE RECOMMENDED OPERATING TEMPERATURE RANGE:** This compressor should only be used in an ambient temperature of between +5°C and +40°C (never at or below freezing temperatures).
2. **NEVER USE AN AIR COMPRESSOR WHICH APPEARS DEFECTIVE OR IS OPERATING ABNORMALLY:** If the compressor operates unusually or makes strange noises, switch off immediately and purge the air reservoir. Arrange repairs with your nearest dealer.
3. **BREATHING QUALITY AIR:** This compressor should not be used to supply breathing quality air.
4. **SAFETY VALVE:** Never remove or attempt to adjust the safety valve. The maximum pressure is factory set. Keep the safety valve free from paint and other accumulations.
5. **AVOID UNINTENTIONAL STARTING:** Do not move the compressor when it is connected to the mains power supply.
6. **BEFORE EACH USE CHECK THE COMPRESSOR AND HOSE FOR DAMAGED PARTS:** Never use the compressor if it has been damaged in any way. Have the compressor repaired by a qualified service engineer. Do not use the compressor if the On/Off switch does not operate correctly.
7. **KEEP THE MOTOR AIR VENTS CLEAR:** Keep the motor vents clear and free from dust. Wipe regularly to maintain an adequate supply of clean air. Avoid using in dusty conditions.
8. **OPERATE THE COMPRESSOR AT THE CORRECT VOLTAGE:** Make sure that the mains supply voltage is the same as the voltage shown on the label.
9. **ALWAYS** adjust the pressure regulator to the recommended setting for the particular spray gun or air tool being used.
10. When using the compressor for painting:
 - Do not work in enclosed areas or near naked flames.
 - Ensure that the area in which you are working has good ventilation.
 - Protect your nose and mouth with a suitable face mask.
 - Always check the safety data sheets for substances being sprayed & ensure manufacturer's instructions are followed.
11. **DO NOT USE THIS COMPRESSOR TO INFLATE SMALL, LOW-PRESSURE OBJECTS:** Items such as children's toys or footballs can explode if over-inflated.
12. **NEVER STOP THE COMPRESSOR BY REMOVING THE PLUG OR SWITCHING OFF AT THE MAINS SUPPLY:** Always use the On/Off switch on the compressor.

SAFETY SYMBOLS

The following safety symbols are shown on the product or it's packaging. Please read all of the safety and operating instructions carefully before use.

	<p>Read this instruction booklet carefully before positioning, operating or adjusting the compressor.</p>
 <p>LWA</p> <p>97 dB</p>	<p>This compressor produces a high sound level during operation. Ear protection should be worn.</p>
	<p>This compressor contains surfaces which may get hot during operation. Never operate with the motor housing removed.</p>
	<p>This compressor should always be started or stopped by means of the start/stop button located on the control box. This reduces the risk of accidental start-up.</p>
	<p>Wear eye protection when using this compressor.</p>
	<p>Wear ear protection when using this compressor.</p>

ENVIRONMENTAL RECYCLING POLICY



By purchasing this product, the customer is taking on the obligation to comply with current WEEE regulations.

This means that this product must not be disposed of with general household waste. It must be disposed of according to the laws governing Waste Electrical and Electronic Equipment (WEEE) at a recognised disposal facility. This product contains valuable raw materials. Metal products should be taken to your local civic amenity site for recycling of metal products.

ELECTRICAL CONNECTIONS



WARNING! READ THESE ELECTRICAL SAFETY INSTRUCTIONS THOROUGHLY BEFORE CONNECTING THE PRODUCT TO THE MAINS SUPPLY.

Before switching the product on, make sure that the voltage of your electricity supply is the same as that indicated on the rating plate. This product is designed to operate on 230VAC 50Hz. Connecting it to any other power source may cause damage.

This product may be fitted with a non-rewireable plug. If it is necessary to change the fuse in the plug, the fuse cover must be refitted. If the fuse cover becomes lost or damaged, the plug must not be used until a suitable replacement is obtained.

If the plug has to be changed because it is not suitable for your socket, or due to damage, it should be cut off and a replacement fitted, following the wiring instructions shown below. The old plug must be disposed of safely, as insertion into a mains socket could cause an electrical hazard.



WARNING! THE WIRES IN THE POWER CABLE OF THIS PRODUCT ARE COLOURED IN ACCORDANCE WITH THE FOLLOWING CODE: BLUE = NEUTRAL BROWN = LIVE YELLOW AND GREEN = EARTH

If the colours of the wires in the power cable of this product do not correspond with the markings on the terminals of your plug, proceed as follows.

- The **Blue** wire must be connected to the terminal marked **N** or coloured **Black**.
- The **Brown** wire must be connected to the terminal marked **L** or coloured **Red**.
- The **Yellow and Green** wire must be connected to the terminal marked **E** or  or coloured **Green**.

Plug must be BS1363/A approved.

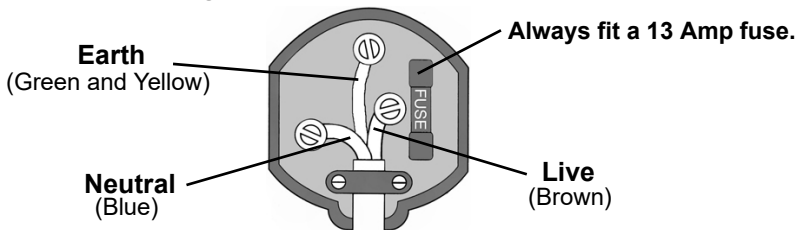

Ensure that the outer sheath of the cable is firmly held by the clamp

We strongly recommend that this machine is connected to the mains supply via a Residual Current Device (RCD). If in any doubt, consult a qualified electrician. DO NOT attempt any repairs yourself.

ASSEMBLY

ATTACH THE WHEELS

Use a suitable spanner and screwdriver to attach the wheels to the compressor.

- Use the washers and spring washer in the positions shown.

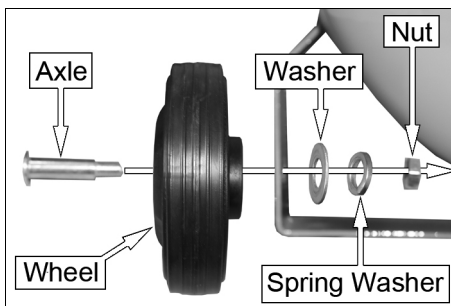

ATTACH THE SUPPORT FEET

Insert the support feet into the position shown.

Use a suitable spanner and screwdriver to attach each foot to the compressor.

- Use the spring washer in the positions shown.

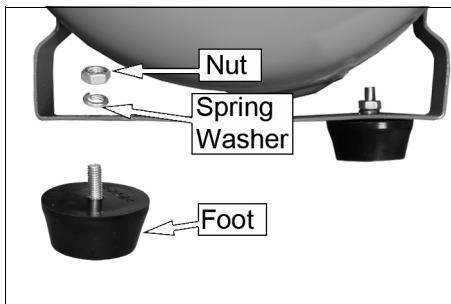

ATTACH THE AIR FILTER

1. Screw the air filters into position.
 - The air filter must be hand tight only.
- One filter fits on each side.

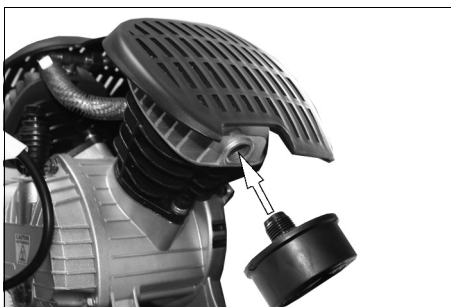

INSTALL THE OIL BREATHER CAP

1. Remove the travel plug.

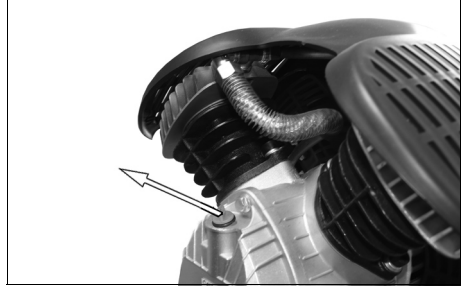

2. Insert the oil breather cap.

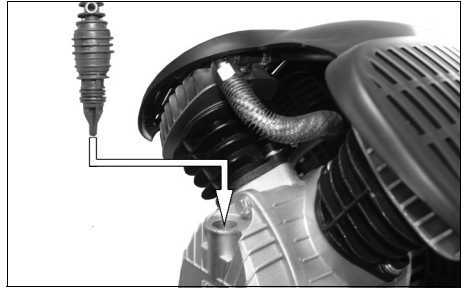

MOVING THE AIR COMPRESSOR



CAUTION: TO PREVENT INJURY, GET ASSISTANCE WHEN LIFTING THIS COMPRESSOR.

1. Stop the compressor and disconnect it from the power supply before you move it.
2. Always use the handle.
3. To prevent damage, do not lift by (or put strain on) valves or hoses.

BEFORE USE

Before connecting your compressor to the power supply, check the following:-

- Set the ON/OFF switch to the OFF position (pushed down).
- Make sure that the compressor is on level ground.
- Make sure that the supply voltage matches the voltage shown on the data label.

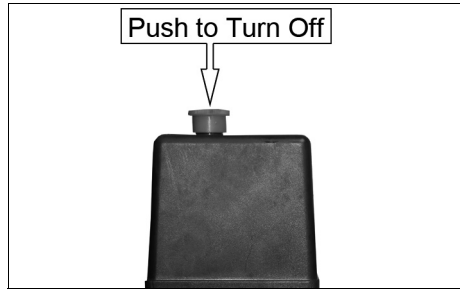

CHECK THE OIL LEVEL

1. Make sure the oil level is half way up the sightglass.

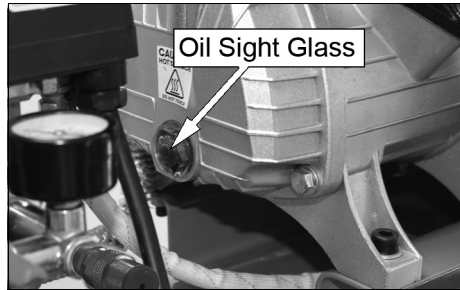

2. If not, remove the oil cap and add oil to the crankcase.
- Only use SAE30 compressor oil, available from your dealer.
 - Only fill to the halfway point on the sightglass. Overfilling may result in damage.

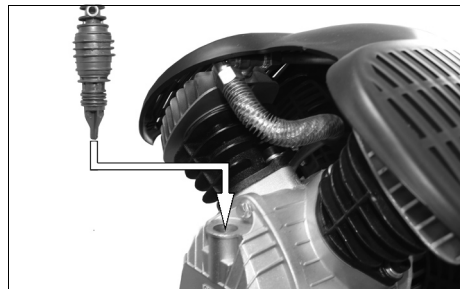

OPERATION

If the compressor has not been used for more than 24 hours, open the drain valve (on the bottom of the reservoir) and drain any condensate which has collected. See page 14.

ATTACHING AIR TOOLS



WARNING: BEFORE CONNECTING AIR TOOLS, MAKE SURE THAT YOU READ THE INSTRUCTIONS SUPPLIED WITH THE TOOL, ALSO ENSURE THAT THE TOOL IS SUITABLE FOR USE WITH THE COMPRESSOR AND HOSE SPECIFICATIONS.

1. Attach the air hose to the $\frac{1}{4}$ " BSP outlet valve.
2. Attach the tool to the end of the air hose.

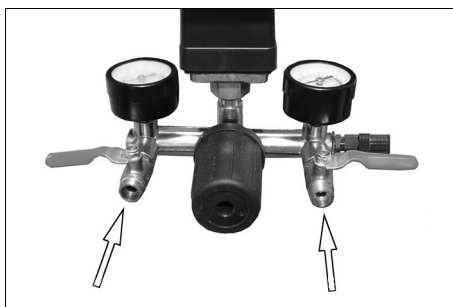

3. Turn the outlet valve handle to the on position.

NOTE: The outlet valve is shown without the air hose fitted for clarity.

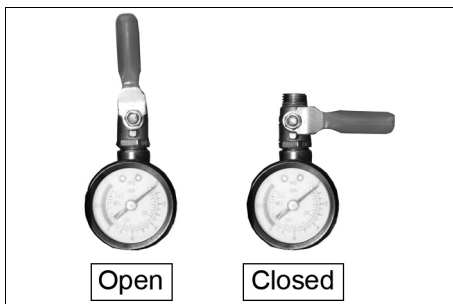

TURNING THE COMPRESSOR ON

1. Plug the compressor into the power supply.
2. Lift the On/Off button.
 - The compressor will operate until the reservoir is fully pressurised. It will then stop.
 - The compressor will start up again when the pressure in the reservoir decreases.

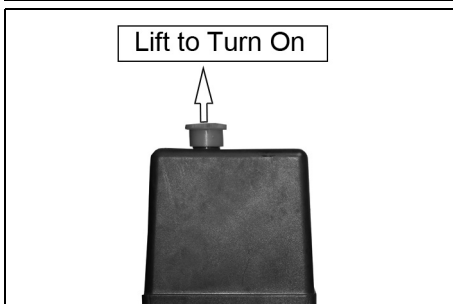

CHECK THE SAFETY VALVE

To make sure that the safety valve works correctly:

1. Unscrew the knurled end and pull it firmly outwards.
 - Air will be released when you pull the cap out and stop when released.
2. If the valve does not operate in this way, do not use the compressor. The compressor must be repaired by a qualified service agent.
3. Screw the knurled end cap back into position.

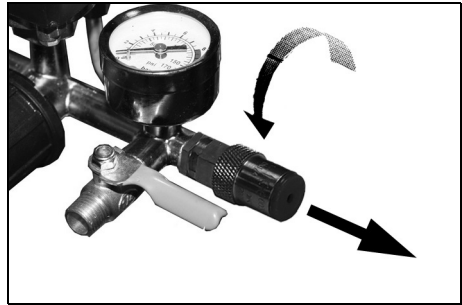

WARNING: DO NOT REMOVE OR TRY TO ADJUST THE SAFETY VALVE.



SET THE OUTPUT PRESSURE

1. Use the pressure regulator to set the output pressure of the left hand outlet valve.
 - Turn clockwise to increase the pressure.
 - Turn counterclockwise to decrease the pressure.

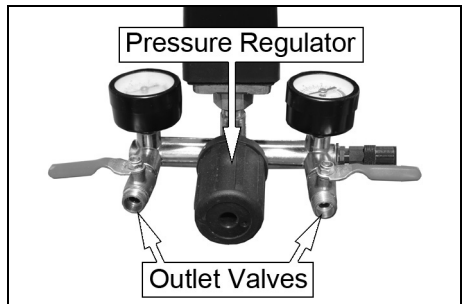

GAUGES

1. The reservoir pressure gauge shows the current pressure in the reservoir.
2. The outlet pressure gauge shows the 'user set' outlet pressure. This can be adjusted as shown above.

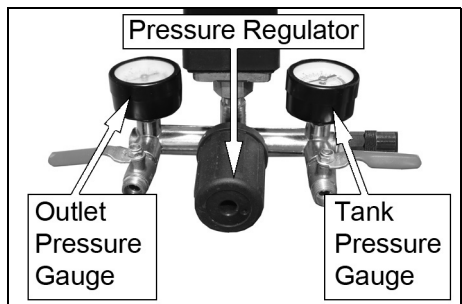

REMOVING AIR DRIVEN TOOLS FROM THE AIR HOSE



WARNING: ALWAYS SET THE PRESSURE REGULATOR TO ZERO BEFORE YOU REMOVE OR REPLACE A TOOL.

1. Push down on the On/Off button to stop the compressor.

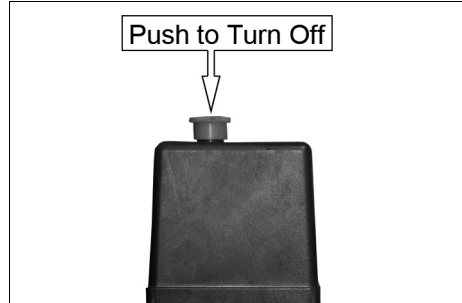

2. Turn the outlet valve handle to the closed position.
3. Operate the tool to depressurise the air hose.
4. Disconnect the tool from the hose.

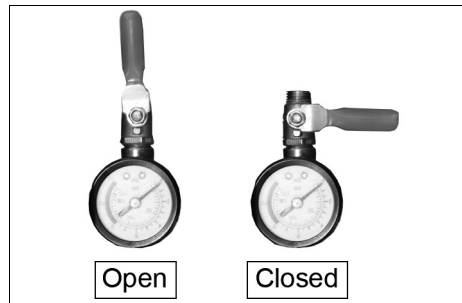

TURNING THE COMPRESSOR OFF

1. Follow steps 1-3 in "Removing Tools From The Air Hose" above.
2. Disconnect the compressor from the power supply.
3. Slowly open one of the outlet valve to depressurise the reservoir.
 - You will hear a hissing sound as the reservoir depressurises.
 - Do not leave the compressor unattended if the reservoir is pressurised.



DRAINING THE RESERVOIR



CAUTION: YOU MUST DRAIN THE RESERVOIR AFTER EACH DAYS USE AND BEFORE YOU PUT YOUR COMPRESSOR INTO STORAGE

1. Turn the compressor off and disconnect from the power supply.
2. Slowly open one of the outlet valves to depressurise the tank.
 - You will hear hissing sound as the reservoir depressurises.
 - Do not leave the compressor unattended if the reservoir is pressurised
3. Put a container below the drain valve to collect the condensate.
4. Open the drain valve slowly.
 - Condensation will drain from the reservoir.
5. Close the drain valve when the reservoir has fully drained.

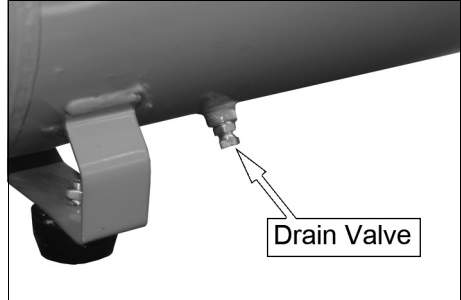

RESET BUTTON

This compressor has a thermal overload device.

If the motor gets too hot, the thermal overload device cuts the power which prevents damage to the motor.

If the thermal overload device operates, let the motor cool down for 5 minutes and push the reset button.

If you start the compressor and the overload cutout operates again, stop the compressor and disconnect from the power supply and have your compressor examined by a qualified service agent.

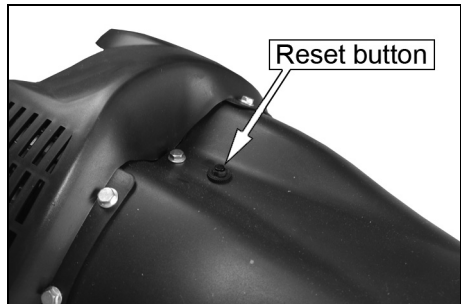

MAINTENANCE

CHECKING THE OIL LEVEL (DAILY)

1. Make sure that the oil level is half way up the oil sightglass.
2. If not, remove the oil breather cap and add oil to the reservoir.
3. Only use SAE30 compressor oil, available from your local dealer.

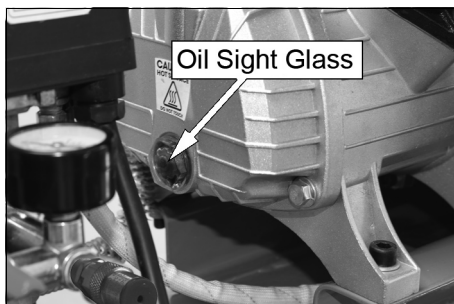

DRAIN THE RESERVOIR (DAILY)

After use, always open the drain valve to make sure that any condensate is drained off.

CLEAN THE AIR FILTER (MONTHLY)

The air filter must be examined monthly, more often in dusty conditions,

1. Remove the filter cover from the filter.
2. Remove the sponge filter.
3. Use a soft brush to clean the sponge and the filter cover.
 - If necessary, the filter can be carefully cleaned in warm soapy water.
 - Rinse and let the filter dry completely before refitting.
4. Make sure that the filter and filter cover are replaced into position.
 - If the filter is damaged, you must replace it.

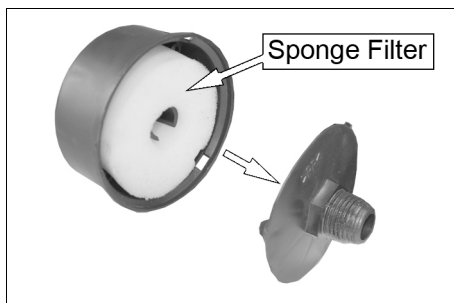

CLEANING & STORAGE

Keep the compressor free of dirt and dust as far as possible. Wipe with a clean cloth or blow it down with compressed air at low pressure. If cleaning is required, use a damp cloth and some soft soap. Do not use cleaning agents or solvents as these may be aggressive to the plastic parts.

Always disconnect the hose and any air tools from the compressor before cleaning or storage. Store the compressor in a dry location. Always store upright.

TROUBLESHOOTING



CAUTION: DO NOT TRY TO REPAIR OR ADJUST THIS COMPRESSOR IF YOU ARE UNCERTAIN OF YOUR ABILITY. IF YOU HAVE ANY QUERIES, CONTACT YOUR DEALER.

PROBLEM	PROBABLE CAUSE	REMEDY
The compressor has stopped and does not start.	Bad electrical connections.	<ol style="list-style-type: none"> 1. Check electrical connections. 2. Clean and tighten if necessary.
	Overload cutout switch has tripped.	<ol style="list-style-type: none"> 1. Switch off and wait approx 5 minutes. 2. Press the reset button and switch on again.
	Motor windings burnt out.	<ol style="list-style-type: none"> 1. Contact your dealer for a replacement motor.
The compressor does not reach the set pressure and overheats easily.	Compressor head gasket blown or valve broken.	<ol style="list-style-type: none"> 1. Return the machine to your nearest service agent.
Compressor does not start.	The reservoir has already fully pressurised.	<ol style="list-style-type: none"> 1. Open drain valve to expel air. Compressor should start again when pressure reduces.
Air leaking from the non-return valve when the compressor is not running.	Faulty non-return valve.	<ol style="list-style-type: none"> 1. Drain receiver completely of air. 2. Remove valve end plug 3. Carefully clean the valve seat and the gasket. 4. Reassemble.
Air pressure from the regulator will not adjust.	The diaphragm within the regulator body is broken.	<ol style="list-style-type: none"> 1. Replace regulator
Compressor is noisy & makes a metallic sound.	Compressor damaged and needs overhaul.	<ol style="list-style-type: none"> 1. Return the machine to your nearest service agent.

DECLARATION OF CONFORMITY



Product Description: Air compressor
Model number(s): Tiger 16550, 50L
Serial / batch Number: 1498510
Date of Issue: 05/09/2019
(Noise Conformity)
Notified Body: TÜV SÜD Industrie Service GmbH
Weidenstraße 199
80686 MÜNCHEN
Germany

Technical Documentation Holder: A.R. Pond
Clarke International
2a Shrubland Road
London E10 7RB
UK

Conformity Assessment Procedure: to 2000/14/EC Annex VI
Manufacturer: Clarke International
Noise Related Value: 2.2kW
Measured Sound Power Level: 95 dB
Guaranteed Sound Power Level: 97 dB



We hereby declare that this product(s) complies with the following directive(s):
2014/30/EU Electromagnetic Compatibility Directive.
2006/42/EC Machinery Directive.
2011/65/EU Restriction of Hazardous substances.
2000/14/EC Noise Emissions Directive, (amended by 2005/68/EC).

The following standards have been applied to the product(s):
EN 1012-1:2010, EN 61000-6-1:2007, EN 61000-6-3:2007+A1:2011, EN 61000-3-2:2014,
EN 61000-3-3:2013.

The technical documentation required to demonstrate that the product(s) meet(s) the requirement(s) of the aforementioned directive(s) has been compiled and is available for inspection by the relevant enforcement authorities.

The CE mark was first applied in: 2019

Signed:

J.A. Clarke
Director

COMPONENT PARTS

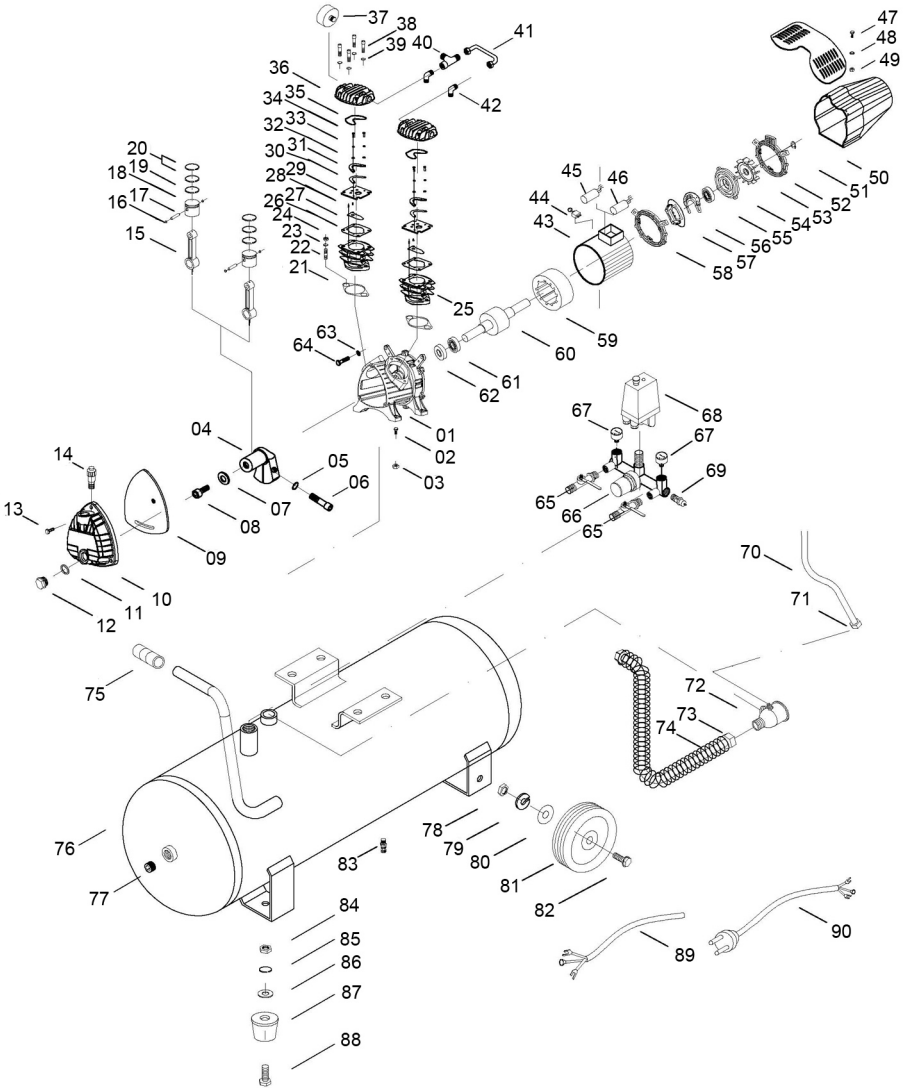

1	CRANKCASE
2	BOLT
3	NUT
4	CRANKSHAFT
5	FLAT WASHER
6	BOLT
7	FLAT WASHER
8	BOLT
9	OIL SEAL GASKET
10	FRONT COVER
11	OIL SIGHTGLASS SEAL
12	OIL SIGHTGLASS
13	BOLT
14	OIL BREATHER
15	CONNECTING ROD
16	RETAINING CLIP
17	PISTON PIN
18	PISTON
19	OIL RING
20	COMPRESSION RING
21	CYLINDER GASKET
22	BOLT
23	FLAT WASHER
24	NUT
25	CYLINDER
26	VALVE REED
27	PIN
28	VALVE PLATE GASKET
29	VALVE PLATE
30	VALVE REED
31	LIMITING STOPPER
32	FLAT WASHER
33	SPRING WASHER
34	SCREW
35	HEAD COVER SEAL
36	HEAD COVER
37	AIR FILTER
38	OVERLOAD PROTECTOR
39	CAPACITOR
40	CAPACITOR
41	BOLT
42	FLAT WASHER
43	NUT
44	SHROUD
45	CAPACITOR

46	CAPACITOR
47	BOLT
48	FLAT WASHER
49	NUT
50	SHROUD
51	CIRCLIP
52	OUTSIDE BACK COVER
53	FAN
54	BEARING SEAT
55	BEARING
56	CENTRIFUGAL SWITCH
57	CENTRIFUGAL FILM
58	OUTSIDE FRONT COVER
59	STATOR
60	ROTOR
61	BEARING
62	OIL SEAL
63	NUT
64	BOLT
65	AIR TAP
66	REGULATOR
67	PRESSURE GAUGE
68	PRESSURE SWITCH
69	SAFTY VALVE
70	UNLOADING PIPE
71	NUT
72	CHECK VALVE
73	NUT
74	EXHAUSTING PIPE
75	HANDLE COVER
76	TANK
77	CHECK HOLE PLUG
78	NUT
79	SPRING WASHER
80	FLAT WASHER
81	WHEEL
82	BOLT
83	DRAIN VALVE
84	NUT
85	SPRING WASHER
86	FLAT WASHER
87	FOOT
88	BOLT
89	MOTOR CABLE
90	POWER CABLE

Machine Mart

A SELECTION OF OTHER QUALITY PRODUCTS

AIR COMPRESSORS

From DIY to industrial. Plus air tools, spray guns and accessories.

GENERATORS

Prime duty or emergency standby for business, home and leisure.

POWER WASHERS

Hot and cold, electric and engine driven - we have what you need.

WELDERS

Mig, Arc, Tig and Spot. From DIY to auto/industrial.

METALWORKING

Drills, grinders and saws for DIY and professional use.

WOODWORKING

Saws, sanders, lathes, mortisers and dust extraction.

HYDRAULICS

Cranes, body repair kits, transmission jacks for all types of workshop use.

WATER PUMPS

Submersible, electric and engine driven for DIY, agriculture and industry.

POWER TOOLS

Angle grinders, cordless drill sets, saws and sanders.

STARTER/CHARGERS

All sizes for car & commercial use.



For Servicing and Spare Parts, please contact Machine Mart on one of the following numbers

PARTS: 0871 410 1270 SERVICE: 0871 410 1290