

CLARIFICE®



INFRARED QUARTZ WALL HEATER

MODEL NO: IQ2000

PART NO: 6939004

MOUNTING & OPERATION INSTRUCTIONS



GC0715

INTRODUCTION

Thank you for purchasing this CLARKE Infrared Wall Heater.

Before attempting to use this product, please read this manual thoroughly and follow the instructions carefully. In doing so you will ensure the safety of yourself and that of others around you, and you can look forward to your purchase giving you long and satisfactory service.

GUARANTEE

This product is guaranteed against faulty manufacture for a period of 12 months from the date of purchase. Please keep your receipt which will be required as proof of purchase.

This guarantee is invalid if the product is found to have been abused or tampered with in any way, or not used for the purpose for which it was intended.

Faulty goods should be returned to their place of purchase, no product can be returned to us without prior permission.

This guarantee does not effect your statutory rights.

ENVIRONMENTAL RECYCLING POLICY



Through purchase of this product, the customer is taking on the obligation to deal with the WEEE in accordance with the WEEE regulations in relation to the treatment, recycling & recovery and environmentally sound disposal of the WEEE.

In effect, this means that this product must not be disposed of with general household waste. It must be disposed of according to the laws governing Waste Electrical and Electronic Equipment (WEEE) at a recognised disposal facility.

If disposing of this product or any damaged components, do not dispose of with general waste. This product contains valuable raw materials. Metal products should be taken to your local civic amenity site for recycling of metal products. Gas filled heater tubes should be disposed of appropriately.

SAFETY PRECAUTIONS

GENERAL

1. Always read and ensure you fully understand the following precautions and the hazards associated with this type of heater. Do not allow anyone who has not read these instructions to operate this heater. Please keep these instructions in a safe place for future reference.
2. Always check for damage before using the heater. Any damage should be properly repaired or the part replaced. If in doubt, DO NOT use the heater and consult your local Clarke dealer.
3. Never carry out any modifications to this product. If experiencing difficulty of any kind consult your local dealer.
4. Use the heater in accordance with any applicable fire regulations.

OPERATING ENVIRONMENT

1. Never use the heater where petrol, paint thinners or other highly flammable vapour or where high levels of airborne dust may be present.
2. Never locate the heater facing combustible materials such as screens, workshop furniture etc.
3. Disconnect the heater from the power supply when not in use.
4. Never place anything on top of the heater so as to impede free air flow.
5. Do not expose the heater or power cable to rain or wet conditions. Any water entering the heater will increase the risk of electric shock. If used outdoors, the heater should be protected from direct rainfall.
6. Never locate the heater near combustible materials such as curtains, furniture etc. Allow at least 1 metre distance.
7. Allow a distance of at least 1 metre from adjacent wall and avoid installing the heater close to power socket outlets.
8. Do not allow the heating element to become covered with dust which could become a fire hazard. If used in a dusty workplace it should be cleaned as described under Cleaning and Maintenance.
9. Never touch the heater element for at least 15 minutes after switching off.
10. Do not leave the heater unattended.
11. Do not use this heater with a programmable timer used to switch it on automatically.
12. Never attach any duct work in front of the heater.

PERSONAL SAFETY

1. When the heater is to be operated in the presence of other people the user is responsible for informing those present of the safety precautions and of the hazards involved.
2. The heater is not to be used by children or persons with reduced physical, sensory or mental capabilities, or lack of experience and knowledge.
3. Always ensure that people and animals are well away from the front of the heater when in operation.
4. This heater will be hot when in operation and should not be touched until it has fully cooled down after switching off.
5. Never leave the heater in use without adult supervision if children or animals are likely to be present.
6. Do not use this heater in small rooms when occupied by persons unable to leave the room on their own unless constant supervision is provided.



ELECTRICAL SAFETY

1. Make sure that the voltage on the rating label is the same voltage as the power supply. If in doubt consult a qualified electrician.
2. Never modify the plug in any way. Do not use adaptor plugs with earthed appliances. Correct plugs and outlets will reduce the risk of electric shock.
3. Do not abuse the electrical cable. Keep the cable away from sources of heat, sharp edges or moving parts. Damaged or tangled cables increase the risk of electric shock.
4. Regularly inspect the power cable for damage. DO NOT use if damaged & keep it away from the source of heat. If damaged, it must be replaced.

DAMAGE & REPAIRS

1. If necessary, have your heater repaired by a qualified person using identical replacement parts to maintain the safety of the heater.

SAFETY SYMBOLS

	Hot surface, do not touch.		Do not cover.
---	----------------------------	---	---------------

The above symbols are found on the heater.

ELECTRICAL CONNECTIONS



WARNING! READ THESE ELECTRICAL SAFETY INSTRUCTIONS THOROUGHLY BEFORE CONNECTING THE PRODUCT TO THE MAINS SUPPLY.

Before switching the product on, make sure that the voltage of your electricity supply is the same as that indicated on the rating plate. This product is designed to operate on 230VAC 50Hz. Connecting it to any other power source may cause damage.

This product may be fitted with a non-rewireable plug. If it is necessary to change the fuse in the plug, the fuse cover must be refitted. If the fuse cover becomes lost or damaged, the plug must not be used until a suitable replacement is obtained.

If the plug has to be changed because it is not suitable for your socket, or due to damage, it should be cut off and a replacement fitted, following the wiring instructions shown below. The old plug must be disposed of safely, as insertion into a mains socket could cause an electrical hazard.



WARNING! THE WIRES IN THE POWER CABLE OF THIS PRODUCT ARE COLOURED IN ACCORDANCE WITH THE FOLLOWING CODE: BLUE = NEUTRAL BROWN = LIVE YELLOW AND GREEN = EARTH

If the colours of the wires in the power cable of this product do not correspond with the markings on the terminals of your plug, proceed as follows.

- The wire which is coloured **Blue** must be connected to the terminal which is marked **N** or coloured **Black**.
- The wire which is coloured **Brown** must be connected to the terminal which is marked **L** or coloured **Red**.
- The wire which is coloured **Yellow and Green** must be connected to the terminal which is marked **E** or  or coloured **Green**.

Plug must be BS1363/A approved.

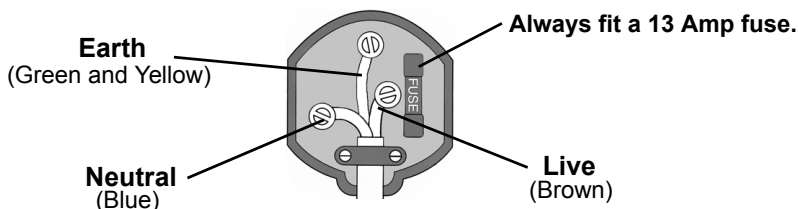

Ensure that the outer sheath of the cable is firmly held by the clamp

We strongly recommend that this machine is connected to the mains supply via a Residual Current Device (RCD)

If in any doubt, consult a qualified electrician. DO NOT attempt any repairs yourself.

PREPARATION

UNPACKING

Remove heater from the carton and check for any damage sustained in transit. Notify your Clarke dealer immediately of any defects.

MOUNTING THE HEATER

The heater is resistant to splashing but should be sheltered from direct rainfall, as should the power cable, plug and supply outlet socket. If used outdoors, an awning, overhanging roof or other shelter should be used to protect from rain.

The heater must be mounted on a suitable wall at a height not less than 1.8m above the floor.

The heater should be positioned with at least 1m clearance at the front between the heater and any obstruction including walls or other combustible surfaces. Always position the heater facing the centre of the space to be heated, not pointing directly at any nearby surfaces. Never place any objects on, or against the heater.

Any equipment or furniture should be a safe distance away, as they could be adversely affected by heat. Take care that the heat is not directed at curtains or other fabrics.

1. Drill four holes in the wall to accept the plastic wall-plugs supplied, at the distance apart as shown. Other wall plugs may be required, dependant upon the construction of the wall.
2. Screw the mounting bracket to the wall.
3. Fit the heater onto the wall bracket and secure in place with the screw knob.
4. Set the downwards angle of the heater by loosening the mounting bracket with a large x-head screwdriver and adjusting the angle before re-tightening.

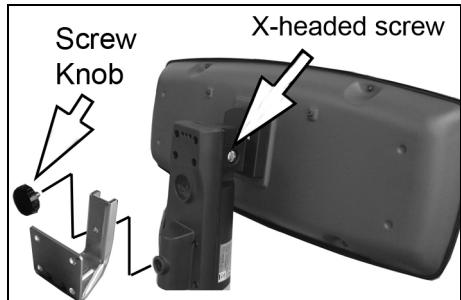
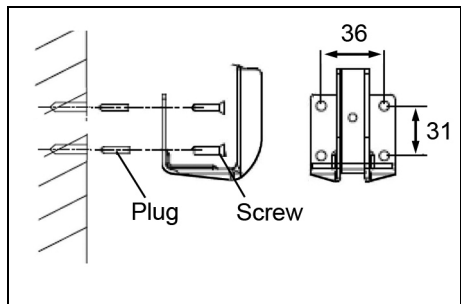

OPERATION

1. Connect the mains cable to a suitable power socket.
2. Pull the string repeatedly to cycle through the following heat settings;

- **O** = Off
- **I** = Low
- **II** = Medium
- **III** = High

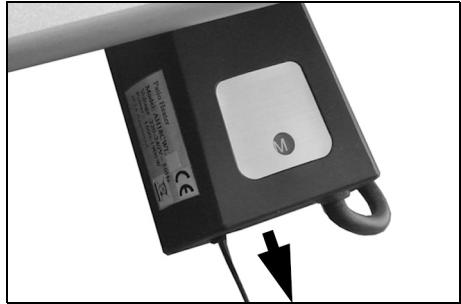

CLEANING AND MAINTENANCE



WARNING: BEFORE CARRYING OUT ANY MAINTENANCE, ENSURE THE HEATER IS SWITCHED OFF, DISCONNECTED FROM THE MAINS SUPPLY, AND HAS BEEN GIVEN ADEQUATE TIME TO COOL DOWN.

PERIODICALLY

1. If there is any build up of dirt, wipe thoroughly with a damp cloth ,taking care that no moisture enters the heater.
2. Inspect the power cable for damage. Undue heat will cause the cable to stiffen and crack in which case it should be replaced.
3. Ensure heating elements are free of dust (use compressed air to clean if possible. (ALWAYS wear a dust mask if performing this task).
4. Refer to your Clarke dealer if the heater element needs replacing.

FAULT FINDING

SYMPTOM	PROBLEM	SOLUTION
Heater does not operate, although plugged in and switched on.	Plug is loose/ bad connection.	Remove the plug & check the connection of the plug and socket.
	Fuse blown.	Replace if necessary and investigate the cause. If fuse blow repeatedly, consult your Clarke dealer.
	No power at socket outlet	Insert plug into an operational socket.
	Input voltage incorrect.	Ensure power supply matches the rating on the label.

TECHNICAL SPECIFICATION

Dimensions (L x W x H)	178 x 480 x 253 mm
Weight	1.9 kg
Electrical Supply	230 V, 50hz
Power Cable length	1.8 m
Protection Degree	IP24 (water splash resistant)
Operating Temperature	-20 to 30
Tilt Range	Level to -25 degrees
Heat Output	2kW

PARTS DIAGRAM

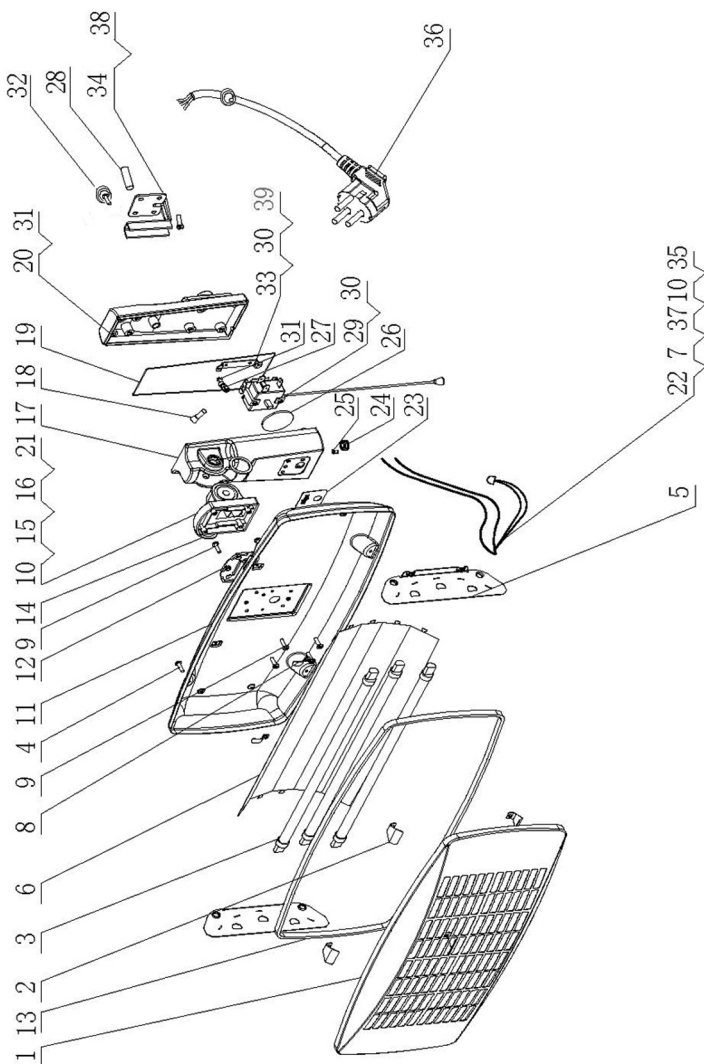

PARTS LIST

ID	DESCRIPTION
1	Front Housing
2	Front Housing Clip
3	Heating Element
4	Self-tapping Screw
5	Reflector Bracket
6	Reflector
7	Nut
8	Cable Clip
9	Self tapping Screw
10	Spring Washer
11	Rear Housing
12	Hinge Board
13	U-seal Ring
14	Hinge Seal
15	Hinge
16	Screw
17	Control Box Bottom
18	Closed End Connector
19	Seal
20	Control Box Cover

ID	DESCRIPTION
21	Nut
22	Internal Wire Assembly
23	PVC Sticker
24	Cable Bush
25	Drawing Bush
26	Display Disc
27	Cable Clamp
28	Plastic Plug
29	Switch
30	Self tapping Screw
31	Self tapping Screw
32	Screw Knob
33	Switch Bracket
34	Wall Bracket
35	Star Washer
36	Power Cable
37	Self-tapping Screw
38	Self-tapping Screw
39	Screw

DECLARATION OF CONFORMITY



Clarke[®]
INTERNATIONAL

Hemnall Street, Epping, Essex CM16 4LG

DECLARATION OF CONFORMITY

This is an important document and should be retained.

We hereby declare that this product(s) complies with the following directive(s):

2004/108/EC *Electromagnetic Compatibility Directive.*

2006/95/EC *Low Voltage Equipment Directive.*

2011/65/EU *Restriction of Hazardous substances.*

The following standards have been applied to the product(s):

EN 55014-1:2006 +A1:2009 +A2:2011, EN 55014-2:1997 +A1:2001 +A2:2008, EN 62233:2008,

EN 61000-3-2:2006 +A1:2009 +A2:2009, EN 61000-3-3:2008, EN 60335-1:2012,

EN 60335-2-30:2009 +A11:2012.

The technical documentation required to demonstrate that the product(s) meet(s) the requirement(s) of the aforementioned directive(s) has been compiled and is available for inspection by the relevant enforcement authorities.

The CE mark was first applied in: 2014

Product Description: Infrared heater(s)
Model number(s): CF11800, CF11800L, IQ2000, IQ2000S
Serial / batch Number: N/A
Date of Issue: 23/04/2015

Signed:



.....

J.A. Clarke
Director

A SELECTION FROM THE VAST RANGE OF

Clarke®

QUALITY PRODUCTS

AIR COMPRESSORS

From DIY to industrial, Plus air tools, spray guns and accessories.

GENERATORS

Prime duty or emergency standby for business, home and leisure.

POWER WASHERS

Hot and cold, electric and engine driven - we have what you need

WELDERS

Mig, Arc, Tig and Spot. From DIY to auto/industrial.

METALWORKING

Drills, grinders and saws for DIY and professional use.

WOODWORKING

Saws, sanders, lathes, mortisers and dust extraction.

HYDRAULICS

Cranes, body repair kits, transmission jacks for all types of workshop use.

WATER PUMPS

Submersible, electric and engine driven for DIY, agriculture and industry.

POWER TOOLS

Angle grinders, cordless drill sets, saws and sanders.

STARTERS/CHARGERS

All sizes for car and commercial use.



PARTS & SERVICE: 0208 988 7400

E-mail: Parts@clarkeinternational.com or Service@clarkeinternational.com

SALES: UK 01992 565333 or Export 00 44 (0)1992 565335

Clarke® INTERNATIONAL Hemnall Street, Epping, Essex CM16 4LG
www.clarkeinternational.com