

**HYUNDAI**  
POWER PRODUCTS

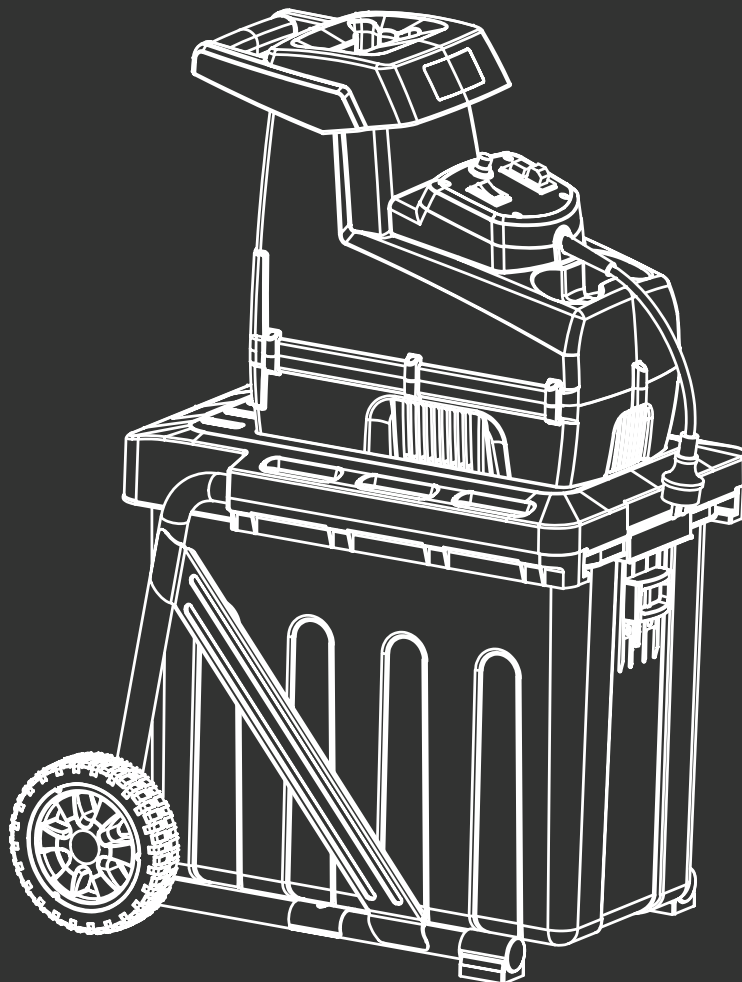

# **GARDEN SHREDDER HYCH2800ES**

Instruction Manual



# Introduction

## Thank You For Purchasing Your HYUNDAI Product

We work very hard to give all of our customers the best possible service. If you have any problems, before leaving negative feedback, please contact us to give us a chance to resolve the issue. We would be delighted if you left us positive feedback! Thank you for purchasing this product.

## Important!



**⚠ WARNING : READ THE INSTRUCTION BOOKLET THOROUGHLY BEFORE USING THE MACHINE.** Keep for future reference and pass it on if the machine is loaned or sold to another user.

This manual has been produced by Hyundai Power Products and should be kept with the product. Please read and understand these instructions before you use your product. Failure to do this may result in personal injury or damage to the product.

The safety precautions and warnings are to ensure your safety and protect you from harm or damage to the product.

The information contained in this manual was accurate at the time of production, however HYUNDAI Power Products may make modifications to the product without notification.



# Contents

<b>Safety Information.....</b>	<b>4-15</b>	<b>Useful Information.....</b>	<b>34</b>
Understand Your Machine.....	4	Our YouTube Channel.....	34
Personal Safety.....	5	Warranty.....	34
Inspect Your Machine.....	6	Manual Updates.....	34
Work Area.....	7	Returning Your Product.....	34
During Use.....	8-10	Leaving A Review.....	34
Batteries.....	10	Ordering Spare Parts.....	34
Electrical Safety.....	11	<b>Contact Us.....</b>	<b>35</b>
Vibrations.....	12		
Noise.....	12		
Personal Protective Equipment.....	13		
Intended Use.....	14		
Symbols On The Machine.....	15		
<b>Features.....</b>	<b>16-17</b>		
<b>Unboxing.....</b>	<b>18</b>		
<b>Assembly.....</b>	<b>19-21</b>		
Assembly Safety.....	19		
Wheel Assembly.....	20		
Install Collection Box.....	21		
<b>Operation.....</b>	<b>22-23</b>		
Overload Protection.....	22		
Instructions For Use.....	23		
<b>Starting / Stopping.....</b>	<b>24</b>		
<b>Maintenance.....</b>	<b>25-29</b>		
Maintenance Safety.....	25		
Checking Your Machine.....	26		
Cleaning.....	26		
Transportation.....	26		
Storage.....	27		
Adjusting The Counterplate.....	28		
Troubleshooting.....	29		
Service.....	29		
<b>Technical Data.....</b>	<b>30</b>		
<b>Recycling And Disposal.....</b>	<b>31</b>		
<b>Our Product Range.....</b>	<b>32</b>		
<b>Declaration Of Conformity.....</b>	<b>33</b>		
<b>Useful Information.....</b>	<b>34</b>		



# Safety Information

## Safety

No list of safety guidelines can be complete. Every environment is different. Always consider safety first, as it applies to your individual working conditions. Use this and other machinery with caution and respect. Failure to do so could result in serious injury, damage to equipment, or poor work results.

Some or all of the following - warning signs and symbols may appear throughout this manual. You **MUST** adhere to their warnings. Failure to do so may result in personal injury to yourself or those around you.

### **DANGER**

Indicates a hazard, which, if not avoided, could result in serious injury or death.

### **WARNING**

Indicates a hazard, which, if not avoided, could result in serious injury.

### **CAUTION**

Indicates a hazard which, if not avoided, might result in minor or moderate injury.

## Understand Your Machine

- **WARNING!** You must read these instructions carefully before operating the machine. Make sure that you are familiar with the controls and properly operate the machine. You must learn how to stop the machine quickly. If you do not follow the warnings and instructions, it may result in fire and/or serious injury. Make sure to save all warnings and instructions for future reference.
- Read this manual and labels affixed to the machine to understand its limitations and potential hazards.
- Be thoroughly familiar with the controls and their proper operation. Know how to stop the machine and disengage the controls quickly.
- If the unit is to be used by someone other than original purchaser, or is to be loaned, rented, or sold, always provide this manual and any needed safety training before operation. The user can prevent and is responsible for accidents or injuries that may occur to themselves, to other people, or to property.
- Do not force the machine beyond its limits. Use the correct machine for your application.
- Know how to stop the machine quickly in case of emergency. Understand the use of all controls.
- **ALL MAINTENANCE** other than that listed in this manual, should be carried out by professionally trained and certified personnel.
- When using this machine for the first time and before actual work, you **MUST** learn how to handle the machine from an experienced or skilled person.



# Safety Information

## ⚠ Personal Safety

- **WARNING!** Never allow children or people unfamiliar with these instructions to use the product. Local regulations can restrict the minimum age of the operator.
- Keep children, pets, and other people not using the unit away from the work area (at least 15m). Be alert and shut off the unit if anyone enters work area. Keep children under the watchful care of a responsible adult.
- Stay alert, watch what you are doing and use common sense when operating the machine. Never operate the machine when unwell or tired, or if you have taken alcohol, medicine, drugs or any substances which may slow your reflexes and compromise judgment. A moment of inattention while operating the machine may result in serious personal injury.
- Appropriate Personal Protective Equipment (PPE), **MUST** be worn at all times when operating or repairing the machine. Always wear anti-slip and resistant work footwear and long trousers while using the machine. Do not use the machine when barefoot, wearing sandals or similar lightweight footwear. Do not wear chains, bracelets or clothing that is loose fitting or hanging ties or cords. Tie long hair back. Always wear protective earplugs. Loose clothes, jewellery, or long hair can be caught in moving parts. Protect eyes, face, and head from objects that may be thrown from the unit. Always wear safety goggles or safety glasses with side shields when operating.
- Always keep hands and feet away from all moving parts during operation. Moving parts can cut or crush body parts. Always keep hands and feet away from all pinch points.
- Do not touch parts that might be hot from operation. Allow parts to cool before attempting to maintain, adjust, or service.
- Do not overreach. Keep proper footing and balance at all times. This enables better control of the machine in unexpected situations. Extending your body too far can result in a loss of balance and you may fall which will result in injury.
- Never place any part of your body where it would be in danger if movement should occur during assembly, installation, and operation, maintenance, repairing or moving.
- Start the machine carefully according to instructions and with feet away from the moving parts.
- Do not place your hands or feet near or under rotating parts. Keep away from any discharge openings.
- Keep in mind that the operator or user is responsible for accidents, hazards or unexpected events involving the machine that occur to other people or their property. It is the responsibility of the user to assess the potential risk of the area where work is being carried out. The operator or user must take all necessary precautions to ensure their own safety and that of others, especially on slopes or rough, slippery and unstable ground.



# Safety Information

## **▲ Inspect Your Machine**

- Check your machine before starting it. Keep guards in place and in working order. Make sure all nuts, bolts, etc., are securely tightened.
- You must check the general condition of the machine before use.
- Never operate the machine when it is in need of repair or is in poor mechanical condition. Replace damaged, missing, or failed parts before using it. Check for fuel leaks. Keep the machine in safe working condition.
- Do not use the machine if the switch does not turn off the machine when running. Any machine that can't be controlled with the switch is dangerous and must be replaced.
- If the machine should start to vibrate abnormally, stop the machine and check immediately for the cause. Vibration is generally a warning sign of trouble.
- Do not tamper with or disable safety systems.
- Only use manufacturer-recommended attachments.
- Before using, always visually inspect to see that the tools are not worn out or damaged. Replace worn out or damaged elements and bolts in set to preserve balance.
- Keep all nuts, bolts and screws tight to ensure the equipment is in safe working condition.
- Keep the machine in good operating condition. Operating the machine in poor or questionable condition could result in serious injury.
- Be sure all safety devices are in working order and warning labels are in place. These items are installed for your safety.



# Safety Information

## **▲ Work Area**

- You must only work in daylight or with good artificial light in good visibility conditions. Do not work at night, at times of heavy fog, or at any other times when your field of vision might be limited and it would be difficult to gain a clear view of the area.
- Keep people, children and animals away from the working area.
- Operate on flat, level ground.
- DO NOT work on wet ground. If there has been heavy rain on the working site, wait until the ground has dried up.
- You must pay special attention when approaching obstacles that could compromise visibility.
- Never park the machine in a place with unstable ground which could give way.
- You must be careful near ravines, ditches or embankments.
- Do not work in the rain, when there is a thunderstorm or lightning risk, at times of strong or gale force winds, or at any other times when the weather conditions might make it unsafe to use this product. If there is bad weather conditions, do not use the machine.
- Do not operate the device on paved or gravel surfaces where ejected material may cause injury.
- Do not use the device near flammable liquids or gases. Risk of fire and explosion in case of short circuit.



# Safety Information

## ⚠ During Use

- Do not operate the machine in confined areas where there may be a risk of crushing the operator between the machine and another object.
- Walk, never run with the machine. Be very careful when pulling the machine toward you. You must look behind you to make sure there are no obstacles before and during operations.
- **WARNING!** If something breaks or an accident happens whilst working, you must turn off the machine immediately and move the machine away to prevent further damage. If an accident happens with injuries or third parties are injured, carry out the first aid measures most suitable for the situation immediately and contact the medical authorities for any necessary health care. Carefully remove any debris that might cause damage or harm persons or animals should it not be seen.
- Do not carry passengers.
- The excessive speed of movement or the absence of maintenance have a significant influence on noise emissions and vibrations. It is necessary to take preventive steps to eliminate possible damage due to high levels of noise and stress from vibration. You must maintain the machine well, wear ear protection and take breaks from working.
- Always turn off the machine and ensure that all moving parts have come to a complete stop before making any repairs, adjustments, or inspections.
- You must switch off the machine and disconnect from the power source (making sure that all moving parts are stationary):
  - Before checking or working on the machine.
  - Before clearing blockages.
  - When transporting the machine.
  - Whenever you leave the machine unattended.
- Keep your face and body away from the feeding chute.
- Hands, other parts of the body or clothing must not be placed in the feeder, in the ejection channel or near moving parts.
- When feeding material, never stand on a level higher than the level of the base of the device.
- Keep a distance from the ejection opening at all times. When feeding material into the device, be extremely careful not to insert metal pieces, stones, bottles, cans, or other foreign objects.
- Do not allow processed material to accumulate in the ejection area as this may prevent proper ejection and cause the material to bounce back through the feed opening.
- Never remove the collection bag when the machine is being operated.
- Never touch under the housing body when the machine is running.





# Safety Information

## ⚠ During Use (Continued)

Switch off the device immediately and wait until all moving parts have come to a standstill in the event of a foreign object being struck or if the device begins to make unusual noises or vibrate. Disconnect the machine from the power source and take the following steps before restarting and operating the machine:

- Check for damage;
- Replace or repair damaged parts;
- Check for loose parts and tighten them.
  
- Before starting the machine, make sure that the feeder is empty.
  
- **Warning!** This power tool generates an electromagnetic field during operation. Under certain circumstances, this field may affect active or passive medical implants. To reduce the risk of serious or fatal injury, we recommend that individuals with medical implants consult your physician and the manufacturer of the medical implant before operating the machine.
  
- Only feed materials to be shredded after the machine is switched on. Do not feed materials to be shredded after the machine is switched off.
  
- The machine is equipped with a safety switch to prevent it from being switched on again accidentally after a power failure.
  
- Do not tilt the machine whilst it is running.
  
- Always stand clear of the discharge zone when operating this machine.
  
- When feeding material into the machine be extremely careful that pieces of metal, rocks, bottles, cans or other foreign objects are not included.
  
- If the machine becomes clogged, shut off the power source and disconnect from power supply before clearing debris. Keep the power source clear of debris and other accumulations to prevent damage to the power source or possible fire.
  
- Do not transport the machine whilst connected to a live power source.
  
- Do not fill soft waster such as kitchen rubbish into the shredder.
  
- Only insert as much material so that the in-feed chute will not be blocked up.
  
- **WARNING!** Long material extending out from the machine could lash out when being drawn in by the blades. Please keep at a safe distance.
  
- Ensure the shredded material can fall freely from the discharge chute.
  
- To make finer compost, the shredded material can be shredded for a second time.



# Safety Information

## ⚠ During Use (Continued)

- Do not allow the shredded material to build up to a level where it blocks the discharge chute. If the material builds up too far it could reach the cutting blades and be thrown out of the in-feed chute.
- Organic material contains a large amount of water and sap that could stick to the shredder. To avoid this, the material should be left for a few days to dry out. However, large branches are best shredded when they are fresh.
- If during cutting the blade stalls, stop the shredder immediately and disconnect it from the mains supply before investigating the cause. Remove and jammed debris from the blades and examine them for any damage before starting shredding again.

## ⚠ Batteries (Where Present)

Batteries present a risk if they become damaged by the possible leaking of electrolyte. This electrolyte is an acid and can cause serious burn injuries. Care should be taken when working on or near them. **NOTE** the electrolyte may be in a liquid or gel form.

Should you come in to contact with electrolyte you should;

- Remove all clothing contaminated with electrolyte. If you cannot remove then saturate them in water.
- Get medical assistance as soon as possible.

You must advise the medical staff of the type of acid.

- Lead/acid battery = dilute sulphuric acid.
- Nickel/cadmium = potassium hydroxide alkali electrolyte.
- Use fresh running water to wash off excess electrolyte, continue this until medical assistance arrives. Make sure that you do not wash the electrolyte to another part of your body or face.
- If electrolyte comes in to contact with Eyes the electrolyte needs to be immediately washed away with large amounts of water. Make sure that you do not wash the electrolyte to another part of your face or body.
- Gasses from charging batteries are highly flammable and great care should be taken to charge in well ventilated areas.
-  There is an explosion risk if the battery terminals are short circuited, when connecting/disconnecting **ALWAYS** exercise great care so that the terminals or battery leads are **NOT** allowed to touch and cause a spark. **ALWAYS** use suitable insulated tools.



# Safety Information

## **⚠ Electrical Safety (Where Applicable)**



**DANGER!**

**ELECTRICITY CAN KILL - NEVER WORK ON LIVE/ENERGISED EQUIPMENT.**

- Prior to carrying out any maintenance work you **MUST** identify electrical isolation methods and isolate all electrical supplies.
- Prior to use and with all electrical supplies isolated, you **MUST** check all electrical cables, plugs and connectors for the following;
  - Are intact and have no signs of damage, to include but not limited to bare wires, chaffing, cuts and loose wiring.
  - If there are any signs of damage, the damaged item **MUST** be taken out of service until the damage has been repaired by an electrically competent person.
  - All trailing cables should be routed so as not to cause any kind of trip hazard.
  - **NEVER** work on or near electricity with wet hands, wet clothing and wet gloves.
- If the cable is damaged during use, it must be disconnected from the mains supply immediately. Do not touch the cable until it has been disconnected from the mains. Do not connect a damaged cable to the power supply and do not touch a damaged cable before disconnecting it from the power supply, as damaged cables can lead to contact with active parts.
- Appliances used at many different locations including wet room and open air must be connected via a residual current device (FI, RCD, PRCD) of 30mA or less.
- Insert the plug of the electrical cable in a socket of suitable shape, voltage and frequency complying with current regulations.
- Keep the connection and extension cables away from dangerous moving parts to avoid damaging them.
- Only use splash proof extension cables approved for outdoor purposes.
- Make sure the machine is switched off before plugging in.
- Do not overload the device. Use the appropriate electrical tool for the job in hand.
- The plug of the electrical tool must fit into the socket. The plug may not be modified in any way. Do not use an adapter plug in conjunction with a grounded electrical tool. Unmodified plugs and the appropriate sockets will reduce the risk of an electrical shock.
- Keep the electrical tools away from rain or damp. Water entering into an electrical device will increase the risk of an electrical shock.
- Arrange the connecting cable in such a way that it cannot be caught by branches or similar when cutting.



# Safety Information

## **⚠ Vibrations (Where Applicable)**

- Prolonged use of hand held (operated) machines will cause the user to feel the effects of/from vibrations. These vibrations can lead to white finger (Raynaud's phenomenon) or carpal tunnel syndrome. This condition reduces the ability of the hand to feel and regulate temperature, causing numbness and heat sensations and may cause nerve damage and circulatory tissue death.
- Not all factors that lead to white finger disease are known, but cold weather, smoking and other diseases that affect blood vessels and blood circulation as well as large and long-lasting impact of shocks are considered factors in the formation of white finger. Note the following to reduce the risk of white finger and carpal tunnel syndrome;
  - Wear gloves and keep your hands warm.
  - Take regular breaks.
  - All of the above precautions may help reduce the risk of white finger disease but not rule out the carpal tunnel syndrome. Long-term and regular users are therefore recommended to observe the condition of your hands and fingers. Seek medical attention immediately if any of the above symptoms should occur.

## **⚠ Noise (Where Applicable)**

- The operating noise of the machine can damage your hearing. When wearing protection such as earplugs or ear defenders to protect your hearing. Long-term and regular users are advised to have hearing checked regularly. Be especially vigilant and cautious when wearing ear protection because your ability to hear alarm warnings will be reduced.
- Noise emissions for this equipment is unavoidable. Carry out noisy work at approved times and for certain periods. Limit the working time to a minimum. For your personal protection and protection of people working nearby it is also advisable for them to wear hearing protection.



- See Certificate of Conformity section for Outdoor Noise declaration of conformity.



# Safety Information

## ⚠ Personal Protective Equipment

Appropriate Personal Protective Equipment (PPE), **MUST** be worn at all times when operating or repairing the machine. No protective equipment can ensure 100% protection.

When selecting PPE, make sure it's CE marked and it suits the user in terms of size, fit, etc. If more than one item of PPE is worn at the same time, make sure they can be used together, e.g. wearing safety glasses may disturb the seal of a respirator, causing air leaks.



### **HAND PROTECTION MUST BE WORN**

Protective electrically non-conductive gloves are highly recommended when working.



### **FOOT PROTECTION MUST BE WORN**

Non-skid heavy duty footwear are highly recommended when working.



### **HEARING PROTECTION MUST BE WORN**

Suitable safety hearing protection is recommended.



### **EYE PROTECTION MUST BE WORN**

Always wear safety glasses/goggles and/or face shields. Everyday eyeglasses have only impact resistant lenses; they are not safety glasses/goggles.



### **PROTECTIVE CLOTHING MUST BE WORN**

Do not wear loose clothing, gloves, scarfs, neckties or jewellery (rings, wrist watches), which can be caught in moving parts.



### **HEAD PROTECTION MUST BE WORN**

Wear a safety helmet with a safety visor.



### **FACE SHIELD MUST BE WORN**

Wear a face shield to protect your face.



### **RESPIRATOR MUST BE WORN**

Wear a respirator.



# Safety Information

## Intended Use

The HYCH2800ES is an electric garden shredder from HYUNDAI.

The garden shredder is manufactured according to the latest safety requirements. Every precaution is only effective when it is followed exactly.

### Intended Use

The machine is designed exclusively for shredding fibrous or woody garden waste such as hedge and tree trimmings, branches, bark or fir cones. The machine must not be filled with stones, glass, metal, bones, plastics or material waste.

### User Types

This machine is intended for use by consumers, i.e. non professional operators. The machine is intended for "DIY" and domestic use only.

This tool is not intended for use by persons (including children) with reduced physical, sensory or mental capabilities, or lack of experience and knowledge, unless they have been given supervision or instruction concerning use of the machine by a person responsible for their safety. Never allow children or people unfamiliar with these instructions to use the tool. Supervise children. This will ensure that children do not play with the unit.

Any other use is not as intended. Improper use is not covered by the warranty and the manufacturer will reject any liability. The user is liable for all injuries to third parties and damage to their property. Operate the unit only in the technical condition as stipulated and delivered by the manufacturer. Arbitrary changes to the unit will exclude the manufacturer from any liability for resulting injury and/or damage.

### Improper Use

Any other usage not in keeping with the above mentioned ones may be hazardous and harm persons and/or damage things. Examples of improper use may include, but are not limited to:









- transporting people, children or animals on the machine
- letting yourself be transported by the machine
- using the machine to tow or push loads

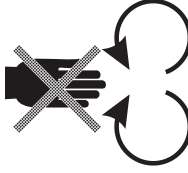

# Safety Information

## Symbols On The Machine

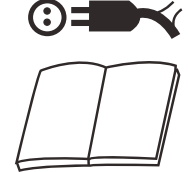
We have provided safety messages in this manual and on the machine. This information alerts you to potential hazards that could hurt you or others. Please read these messages carefully. However, we may not have listed all of the possible hazards, you must also use your own judgment.

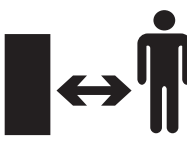
 <p><b>IMPORTANT</b> Please read this instruction manual carefully, especially the safety warnings marked with the symbol.</p>	 <p><b>WARNING</b> Keep dry at all times. Do not expose to rain. Do not use tools in damp or wet locations.</p>
 <p><b>INSTRUCTION MANUAL</b> Read and understand operator's manual before using the machine. Failure to follow instructions could result in death or serious injury.</p>	 <p><b>WARNING</b> Keep hands away from all cutting edges and moving parts. Fingers can be cut or crushed.</p>
 <p><b>PPE</b> Ear muffs and boots with non-slip soles with steel jacket are required. Avoid loose-fitting clothes.</p>	 <p><b>ROTATING PARTS</b> The rotating parts are capable of amputating fingers, toes and feet. Failure to observe could result in serious injury or death.</p>
 <p><b>HAND PROTECTION</b> Protective electrically non-conductive gloves are highly recommended when working.</p>	 <p><b>WARNING</b> Before any adjustment, cleaning and maintenance work, switch off the device and disconnect from the power supply.</p>
 <p><b>SAFETY DISTANCE</b> Do not put hands or feet near or under rotating parts. Keep a 15 metre safety distance.</p>	 <p><b>CE SYMBOL</b> This product complies with the applicable European directives and an evaluation method of conformity for these directives was done.</p>
 <p><b>BYSTANDERS</b> Never allow any bystanders in front of the unit. Keep a 15 metre safety distance.</p>	

# Features

## HYCH2800ES Features

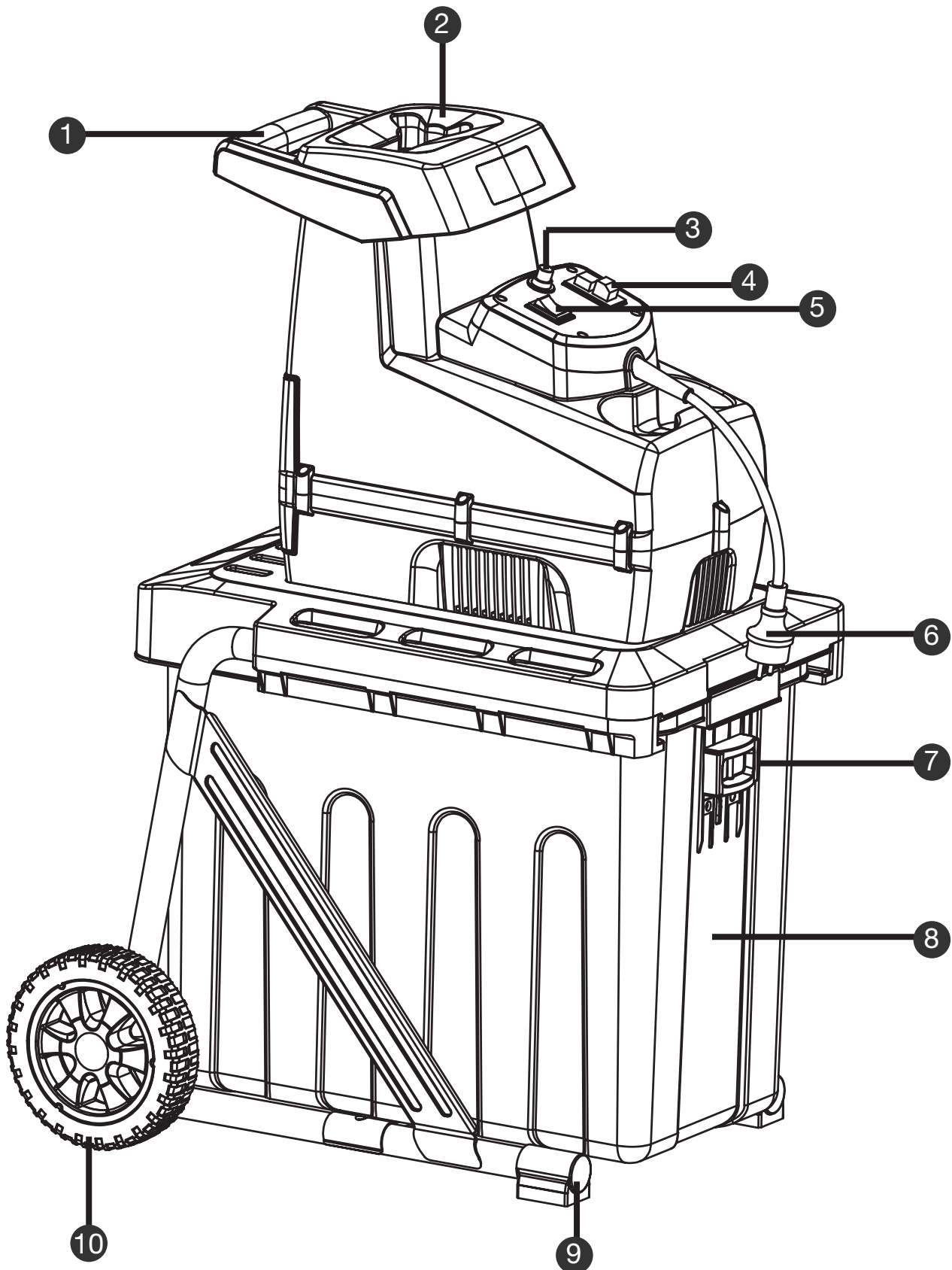



# Features

## HYCH2800ES Features

- 1 Handle
- 2 Feeder Hopper
- 3 Safety Switch
- 4 On / Off Switch
- 5 Forward / Reverse Switch
- 6 Plug
- 7 Lock Button
- 8 Collection Box
- 9 Support Foot
- 10 Wheel



# Unboxing

## ⚠ Unboxing Safety

**⚠ WARNING!** Unboxing and assembling the machine should be done on a flat, stable surface with enough room. Disposal of the packaging should be done in accordance with the local regulations in force.

**⚠ WARNING!** Some of the packaging material may be harmful to children. Keep out of reach of children.

Carefully remove the product from the packaging and examine it for any sign of damage caused during shipping. Lay the contents out and check them. If any part is damaged or missing, you must not use the machine. Contact HYUNDAI Power Products immediately. You must keep the packaging material in case the machine needs to be returned or repaired.

Ensure that you have all the accessories and tools you need for assembly and operation including the suitable personal protective equipment.

## Box Contents

- User Manual
- HYCH2800ES
- Collection Bag



## ⚠ Assembly Safety

**⚠ CAUTION** - This guide is meant to serve as a quick reference for operating your HYUNDAI machine. We always advise reading the manual in full before operation.

**⚠ NOTE** - Images may vary depending on model.

**⚠ NOTE** - The machine may be supplied with some parts already assembled. Prior to assembly, check all items have been received. The mulching plug may already be installed for transport.



# Assembly

## Step 1 : Wheel Assembly

- 1 Turn the shredder upside down and pivot the legs up ward. **(Fig. 1A)**
- 2 Place the supplied wheel axle (A) through the respective openings. **(Fig. 1A)**
- 3 Put the supplied washer (B) and sleeve (C) onto the wheel axle. **(Fig. 1B)**
- 4 Please the wheels (D) and install nut hand tight (E). **(Fig. 1C)**
- 5 Using the supplied hex wrench (F) to fix the wheel axle and at the same time firmly lock the nut by using the wrench (G). **(Fig. 1D)**
- 6 Finally, place the wheel cover (H) in the centre of the wheel. **(Fig. 1E)**

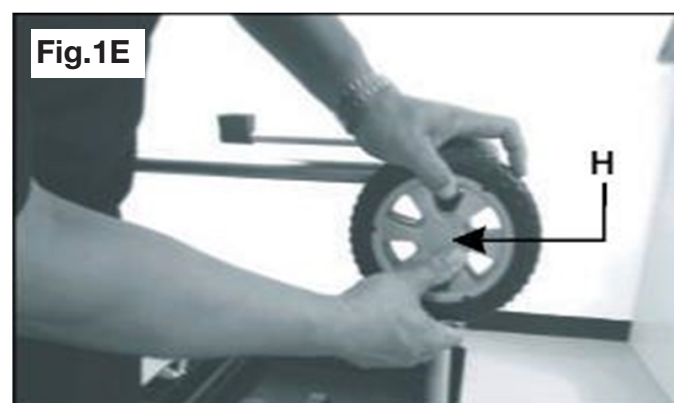
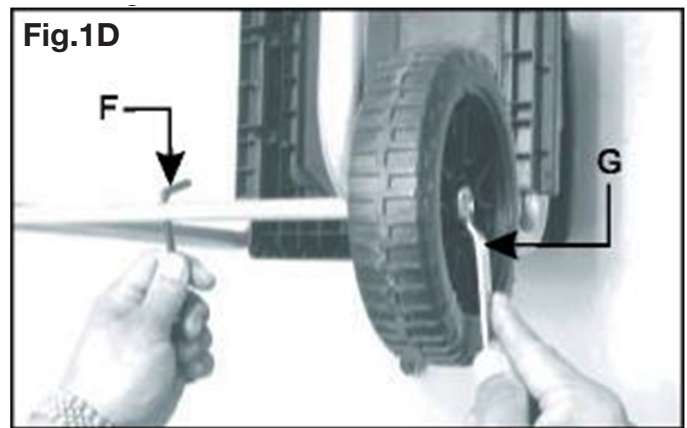
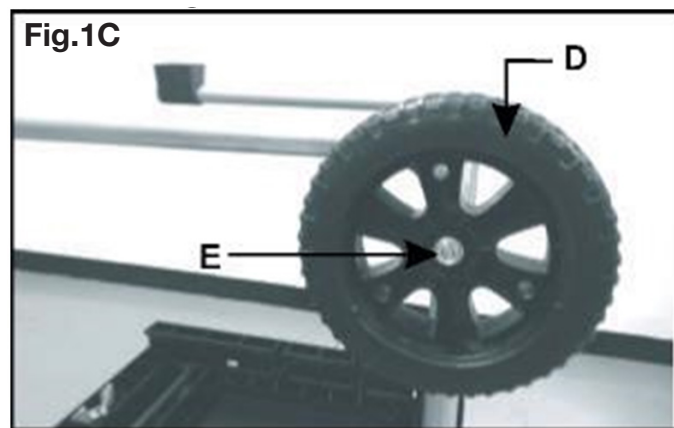
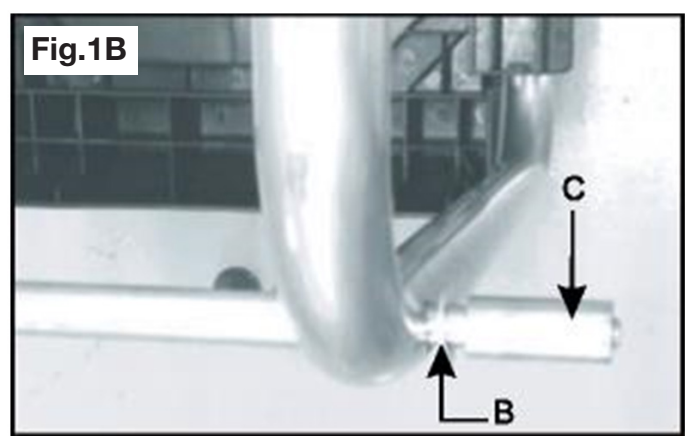

# Assembly

## Step 2 : Install Collection Box

- 1 Press down the lock button (A) and then insert the collection box into the undercarriage. (Fig.2)
- 2 Press the lock button upward before use. (The machine will not run without the button in the up position).

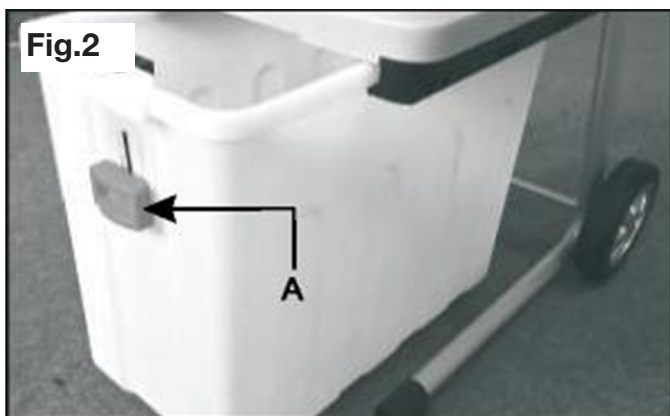

# Operation

## Overload Protection

This machine is equipped with an overload protection system. To protect the motor from being damaged, the safety switch will automatically switch off the power when the motor is overloaded. Wait at least 1 minute before restarting by first pressing the reset button and then the ON / OFF switch.

If the motor does not restart, do the following :

- 1 Press the safety switch (C).
- 2 Press the Forward/Reverse Button (A) to REVERSE " - "  position.
- 3 Press and hold the On/Off switch to ON (I) position to remove any objects that could obstruct the blades.

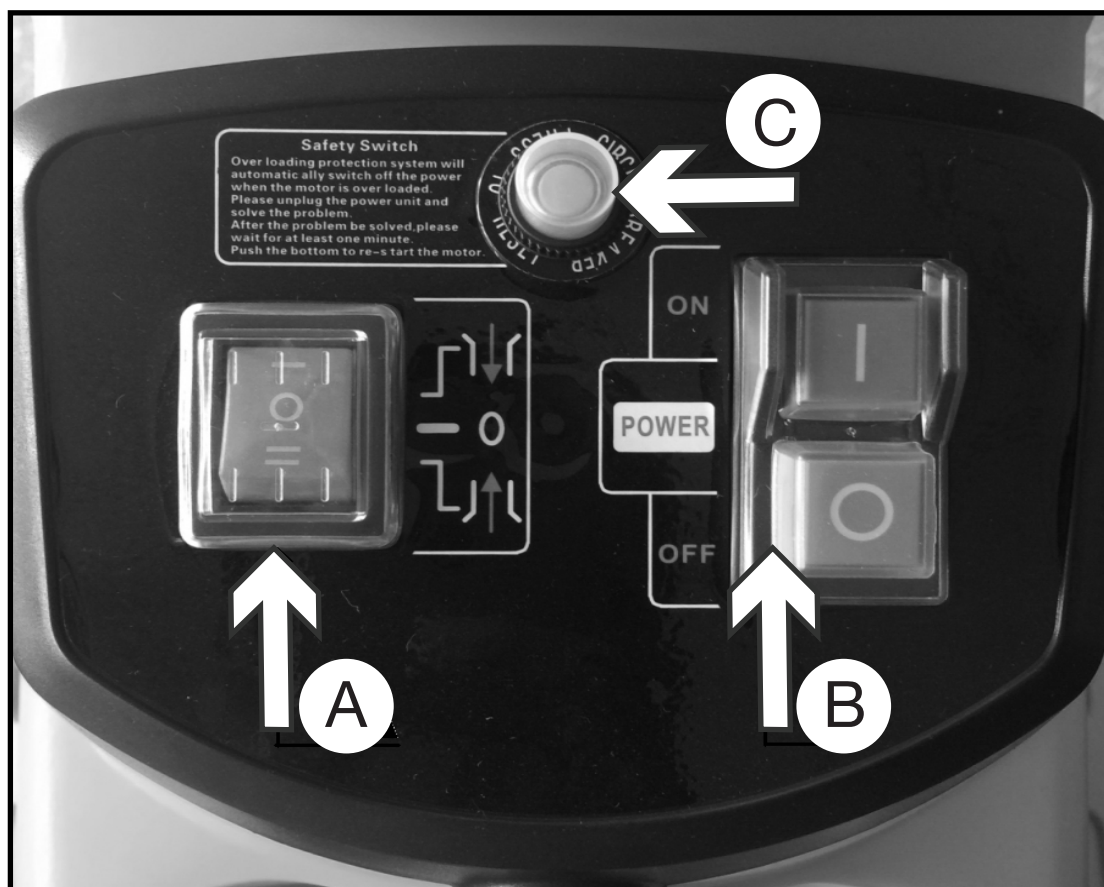

# Operation

## Instructions For Use

- 1 Place the material to be shredded in the opening on the right side. It will be automatically drawn into the machine by the cutter as it turns anticlockwise. Maximum diameter 44mm.
- 2 Do not stuff the opening completely full to avoid jamming the machine.
- 3 Alternate feeding branches and small litter that is a bit wet and decomposed. This will also help to avoid jamming the cutter.
- 4 Squashy kitchen rubbish must be composted, never put it through the shredder.
- 5 Branches with leaves must always be entirely through the shredder and out of the way before feeding new material into the machine. Make sure the shredded material is able to fall unobstructed into the collection box without blocking the outlet.
- 6 The ventilation opening must not be locked by the shredded material.
- 7 Continuous shredding of thick wood or branches can cause the machine to jam.
- 8 Soft material like leaves or sprigs can easily block the inlet ;use a push stick to poke it in.
- 9 Always check litter for nails and stones before shredding as they can seriously damage the shredder.



# Starting / Stopping

**⚠ YOU MUST read and understand the full safety instruction manual before starting the machine.**

## Starting

- 1 Press the forward / reverse switch (A) to "+" position.
- 2 Press the ON / OFF switch (B) to ON (I) position to start the motor.

## Stopping

- 1 Press the ON / OFF switch (B) to OFF (O) position to stop the motor.

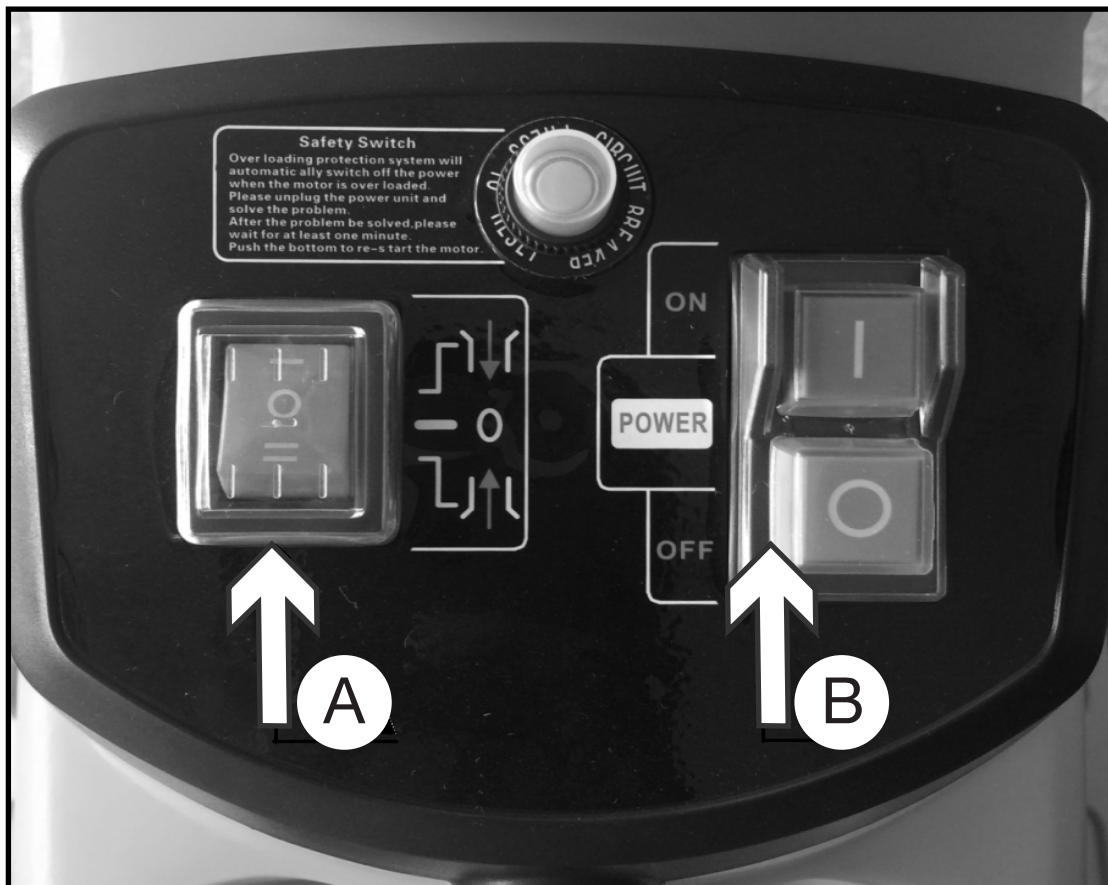





# Maintenance

## Maintenance Safety

 **IMPORTANT** - Routine and accurate maintenance is essential for maintaining original machine safety and performance levels.

 **WARNING** - Before cleaning or doing maintenance work, you need to stop the machine, unplug from the power source and read the relevant instructions. You need to wear proper clothing and protective gloves whenever your hands are at risk.

 If there are worn or damaged parts, never use the machine. Faulty or worn-out parts must be replaced and not repaired. You must only use original spare parts. The use of non-original and/or incorrectly fitted parts will jeopardize the safety of the machine. This may also cause accidents or personal injuries for which the manufacturer is under no circumstance liable or responsible.

 Any maintenance operations or adjustments not explained in this manual must be carried out by your Dealer or a specialised Service Centre with the necessary knowledge and equipment to ensure that the work is done correctly maintaining the machine's original safety level. Any operations performed in unauthorised centres or by unqualified persons will invalidate the Warranty and all obligations and responsibilities of the Manufacturer.

 Be very careful during adjustment of the machine to prevent entrapment of the fingers between moving parts and fixed parts of the machine.



# Maintenance

## Checking Your Machine

When checking your machine, we recommend you:

- Check for worn or damaged parts.
- Make sure all nuts, screws and bolts are tight.
- Make sure all warning stickers are in place and not damaged.

## Cleaning

 **CAUTION - DO NOT** use a hose pipe or pressure washer to clean the machine.

 **NOTE** Machine must be switched off and disconnected from power.

- You must remove grass and mud from the machine to prevent it from drying. This will cause problems the next time the machine is used.
- Wipe the machine down with a cloth.
- For larger build ups of debris, use a scraper or similar product.
- Avoid using solvents when cleaning plastic parts. Most plastics are susceptible to damage from various types of commercial solvents and may be damaged by their use.
- Make sure that the inlet chute and the ejector chute are clean and clear of all waste material.

## Transportation

Whenever the machine is to be handled, lifted, transported or tilted, you must:





- 1 Wear sturdy work gloves.
- 2 Hold the machine at the points that offer a safe grip, taking into account the weight and relative distribution of the same.
- 3 Use an appropriate number of people for the weight of the machine and the characteristics of the vehicle or the place where it must be placed or collected.
- 4 You must make sure that machine movements do not cause damage or injuries.
- 5 During transport, make sure to fasten the machine securely with cables or straps.
- 6 The machine must be transported on a flat surface.



# Maintenance



## Storage

### Where To Store

-  Store in a cool, dry place away from sources of ignition and varying changes in temperature.
-  Store on a flat and level surface with all wheels on the ground.
-  DO NOT stack other items on top of the machine when in storage.
-  Store the machine in a safe place, out of the reach of children or anyone who is not familiar with operation.
-  DO NOT store a machine that has not been given time to fully cool down.

### Before Storage

After use, please follow the below steps before storing your machine.

-  1 Allow the machine to fully cool down.
-  2 Clean the machine. See the 'Cleaning' section.
-  3 Store the machine following the guidelines above.



# Maintenance

## Adjusting The Counterplate

To obtain an optimum shredding result and prevent damage to the blade, the counterplate must be adjusted at regular intervals. The counterplate must also be adjusted if so called interlinkage occurs.

- 1 Turn Counterplate Adjusting Knob (A) clockwise until a slight friction noise can be heard and fine aluminum chips fall from the ejector chute for a short period of time. (Fig. 5A and 5B).
- 2 Then, the materials to be shredded should be fully cut again.

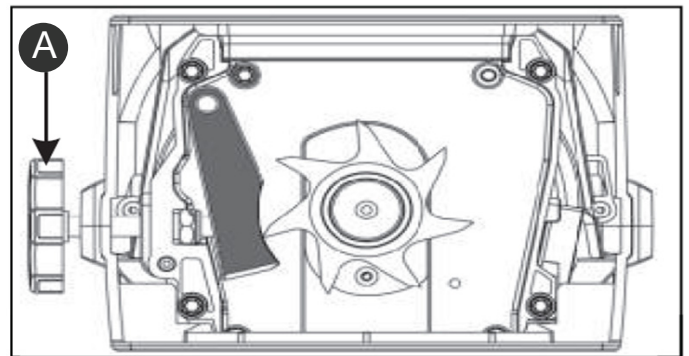
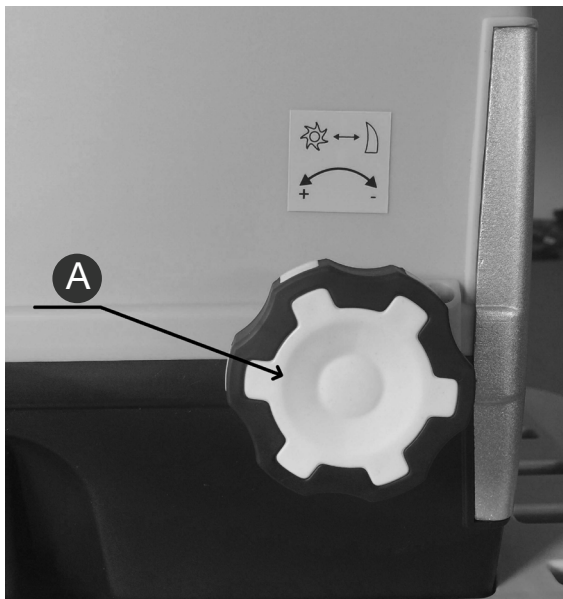

## Replace Counterplate

- 1 Open the back cover by loosening 4 Screws (A). (Fig. 6A)
- 2 Take out the Counterplate (B) and replace a new one. (Fig. 6B)
- 3 Put back the back cover and use wrench to fix the screws.

Fig.6A



Fig.6B

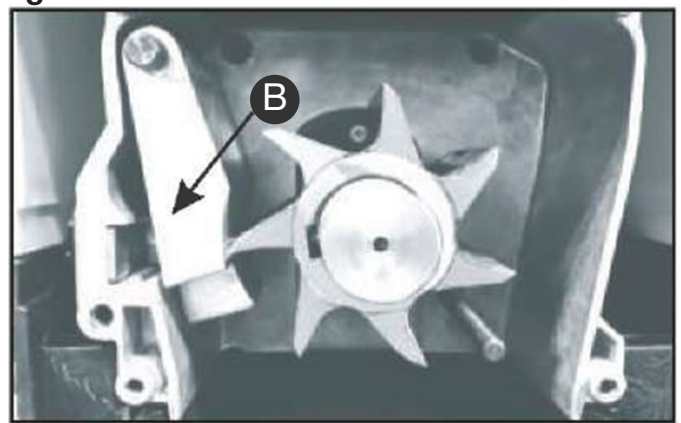

# Maintenance

## Troubleshooting

Problem	Possible Cause	Possible Solution
The motor does not run	Safety switch	Check if the switch still functions well
	Power failure	Check the power supply cable, the plug and the house fuse
The material to be chopped is not drawn in	The material is jammed in the feeding tunnel	Switch the shredder OFF. Pull the material from the feed funnel. Switch the shredder back ON and re-feed thick branches such as that the blade does not immediately engage the pre-cut notches again.
	Shredding material is too soft	Insert wood or shred dried branches
		Press the reset button and then the ON / OFF switch. If it still does not start, take the steps indicated in the 'Overload Protection' section.

## Service

- Only have your electrical tools repaired by qualified specialists and with original replacement parts. This ensures that the safety of the electrical tool is maintained. Do not attempt to repair the machine unless you are qualified to do so.



# Technical Data

## Specifications

<b>Model</b>	<b>HYCH2800ES Electric Garden Shredder</b>
Rated Voltage / Mains Frequency	230V - 50Hz
Rated Input	2800W
Speed	60rpm
Brand Diameter Max. (Depends On The Hardness Of The Wood)	44mm
Safety Class	II
Degree Of Protection	IPX4
Collection Box Capacity	60L
Measured Sound Power Level	91.7dB(A) K=3
Guaranteed Sound Power Level	96dB(A)
Net Weight	20.8kg



# Recycling And Disposal

## Recycling And Disposal



We do not offer a takeback scheme for the recovery of Waste Electrical Electronic Equipment (WEEE) & Batteries. Instead the responsibility to dispose of WEEE and/or Batteries is passed onto you by us.

So when it becomes necessary to dispose of your machine you must take it to your local Civic Amenity Site. For further information please contact your local Authority for disposal advice.

You **MUST** make sure that all unused oil and fuel is disposed of correctly either beforehand or at your local Civic Amenity Site.

- Under NO circumstances must any fuel or oil be put down any drains.
- Certain products contain WEEE waste which should not be disposed of in your domestic waste.
- You **MUST** recycle WEEE in accordance with your local authority or recycling centre.
- Certain products contain batteries which should not be disposed of in your domestic waste.
- You **MUST** recycle batteries in accordance with your local authority or recycling centre.
- Unwanted packaging and materials should be stored and taken to a recycling centre so it can be disposed of in a manner which is compatible with the environment.

We are a Member of the VALPAK National Compliance Scheme and our registration number is **RM08660**. For further information about disposal please contact your Local Authority.

You can also get more advice and guidance about recycling at the following website  
<http://www.recycle-more.co.uk>

Should you pass this product on to another user either sold or loaned, you **MUST** pass on this user manual. This will make sure that all other users can use and maintain this machine safely.

## Environmental Protection

1. Environmental protection should be a priority of considerable importance when using the machine, for the benefit of both social coexistence and the environment in which we live. Try not to cause any disturbance to the surrounding area.
2. You must comply with local regulations and provisions for the disposal of packaging, oils, petrol, filters, damaged parts or any elements which have a strong impact on the environment. This waste must not be disposed of as normal waste. It needs to be separated and taken to specified waste disposal centres where the material will be recycled.
3. You must comply with local regulations for the disposal of waste materials after mowing.
4. When disposing, do not pollute the environment with the machine, but hand it over to a disposal centre, in accordance with the local laws in force.



# Our Product Range

## Generators

Leisure Inverter, Petrol, Diesel And Built-In Motorhome Generators

## Pressure Washers

Petrol, Diesel And Electric Pressure Washers

## Water Pumps

Submersible, Clean And Dirty Water And Professional Chemical Water Pumps

## Lawnmowers

Petrol, Cordless, Electric, Roller, Self Propelled, Electric Start And Robotic Lawnmowers

## Grass Trimmers And Brush Cutters

Petrol, Cordless, Electric And Wheeled Grass Trimmers And Brush Cutters

## Chainsaws

Petrol, Cordless And Electric Chainsaws

## Hedge Trimmers

Petrol And Cordless Hedge Trimmers

## Leaf Blowers

Petrol, Electric, Cordless, Backpack And 3 -in-1 Leaf Blowers

## Log Splitters

Horizontal, Vertical, Petrol And Electric Log Splitters

## Wood Chippers

Petrol And Electric Start Wood Chippers

## Tillers

Petrol Garden Tiller And Cultivator

## Earth Augers And Trenchers

Petrol Earth Augers And Heavy Duty Trenchers

## Compactor Plates

Petrol Compactor Plates

## Cement Mixers

Portable Electric Cement Mixers

## Mini Dumpers

4-Wheel Drive Mini Dumpers And Tracked Dumpers

## Yard Sweeper

Self Propelled Yard Sweeper Power Brush

## Scarifiers

Petrol Lawn Scarifier And Aerator

## Stump Grinders

Petrol 4-Stroke Stump Grinders

## Welders And Plasma Cutters

MIG, TIG, MMA, ARC Welders And Plasma Cutters

## Power Tools And Tool Chests

Electric And Cordless Power Tools And Filled Tool Chests

## Vacuum Cleaners

Wet And Dry Vacuum Cleaners

## Engines

Petrol And Electric Start Engines

## Battery Chargers / Starters

6V, 12V, 24V Battery Chargers, Jump Starters And Hydraulic Floor Jack

## Air Compressors

Home, Domestic, DIY And Professional Use Air Compressors

## Lighting Towers

Mobile Lighting Towers With Diesel Generators

## Portable Power Stations

Camping Power Packs And Solar Chargers

## And More

We Are Constantly Expanding Our Range With New Products

If you would like more information on any of these products, please contact our sales team on 01646 687880 or visit our website [www.hyundaipowerproducts.co.uk](http://www.hyundaipowerproducts.co.uk)





# Declaration Of Conformity

## EC Declaration of Conformity

We hereby declare that the machine detailed in this declaration complies to all the relevant provisions of the following EC directives.

- 2006/42/EC The Machinery Directive
- 2014/30/EU Annex II Electromagnetic Compatibility Directive
- 2000/14/EC & 2005/88/EC Outdoor Noise Emissions Directive

And is in conformity with the applicable requirements of the following documents:

- EN ISO 3744:1995
- EN60335-1:2012/A2:2019, EN 50434:2014
- EN 55014-1:2017, EN55014-2:2015, EN6100-3-2:2014/19, EN6100-3— 11:2000

Delclaration for 2000/14/EC Noise Emissions in the Environment by Equipment for use Outdoors.

Notified Body for EC Directive 2000/14/EC TÜV Rheinland (Shanghai) Co., Ltd.

Model	Type	Motor Watts	Measured Sound Power	Guaranteed Sound Power
HYCH2400E HYCH2800E	Electric Chipper/Shredder	2400w 2800W	103.8dB(A) 91.7dB(A)	106dB(A) 96dB(A)

### Product Details:

Brand: Hyundai

Model: HYCH2400E, HYCH2800E

Description: Electric Chipper/Shredder

### Name and address of technical documentation holder and EU distributor:

Genpower Ltd, Isaac Way, Pembroke Dock, Pembrokeshire, SA72 4RW, UK.

Signed by:



Roland Llewellyn, Managing Director

Date: 14/11/2020



# Useful Information

## Check Out Our YouTube Channel

Our videos on YouTube include:

- Unboxing
- Assembly of your machine
- How to service your machine
- Products in use
- 'How To' videos
- Product features

Go to [www.hyundaisupport.co.uk](http://www.hyundaisupport.co.uk) or search 'Hyundai Power Products' in YouTube.

## Warranty

Proof of purchase will be required before you make a warranty claim.

Full warranty terms and conditions can be found on the HYUNDAI POWER PRODUCTS website: [www.hyundaipowerproducts.co.uk](http://www.hyundaipowerproducts.co.uk)

## Manual Updates

Our manuals are constantly being reviewed and updated. Should you find an error, omission or something unclear, please contact us for assistance.

We reserve the right to make any modifications without prior notice whenever necessary.

Our latest manuals are also placed online.

All our manuals can be downloaded at: [www.hyundaipowerproducts.co.uk](http://www.hyundaipowerproducts.co.uk)

## Returning Your Product

If you are returning your product, please contact the dealer for their returns policy.

## Leaving A Review

We work very hard to give all of our customers the best possible service. If you have any problems, before leaving negative feedback, please contact us to give us a chance to resolve the issue. We would be delighted if you left us positive feedback!

To leave a review, please go to: [uk.trustpilot.com/review/hyundaipowerequipment.co.uk](http://uk.trustpilot.com/review/hyundaipowerequipment.co.uk)

## Ordering Spare Parts

Only use original spare parts: The use of non-original and/or incorrectly fitted parts will jeopardize the safety of the machine, may cause accidents or personal injuries for which the Manufacturer is under no circumstance liable or responsible.



# Need Help? Talk To Our Experts

## Contact Us

Our friendly aftersales team will be more than happy to help you.



### Phone

Call our team on 01646 687880, open Monday-Friday 8.30am-5pm.



### Email

[aftersales@hyundaipowerproducts.co.uk](mailto:aftersales@hyundaipowerproducts.co.uk)



### Online Live Chat

Go to [www.hyundaipowerproducts.co.uk](http://www.hyundaipowerproducts.co.uk)

Live chat is open Monday-Friday from 8.30am-5pm.



### Post

Genpower Limited, Isaac Way, Pembroke Dock, Pembrokeshire, SA72 4RW, UK.



# HYUNDAI

POWER PRODUCTS

Importer:  
GENPOWER LTD  
Isaac Way, London Road,  
Pembroke Dock, UNITED KINGDOM, SA72 4RW  
T: +44 (0) 1646 687 880 F: +44 (0) 1646 686 198  
E: [info@hyundaipowerproducts.co.uk](mailto:info@hyundaipowerproducts.co.uk)  
[www.hyundaipowerproducts.co.uk](http://www.hyundaipowerproducts.co.uk)

Imported/Distributed by Genpower Ltd for The United Kingdom & Ireland

Licensed by Hyundai Corporation, Korea