

THE TOOL COMPANY

BENCH GRINDERS

■ STOCK No. 29620
29621

■ PART No. GHD150
GHD200

• INSTRUCTIONS •

IMPORTANT: PLEASE READ THESE INSTRUCTIONS CAREFULLY TO ENSURE THE SAFE AND EFFECTIVE USE OF THIS TOOL.

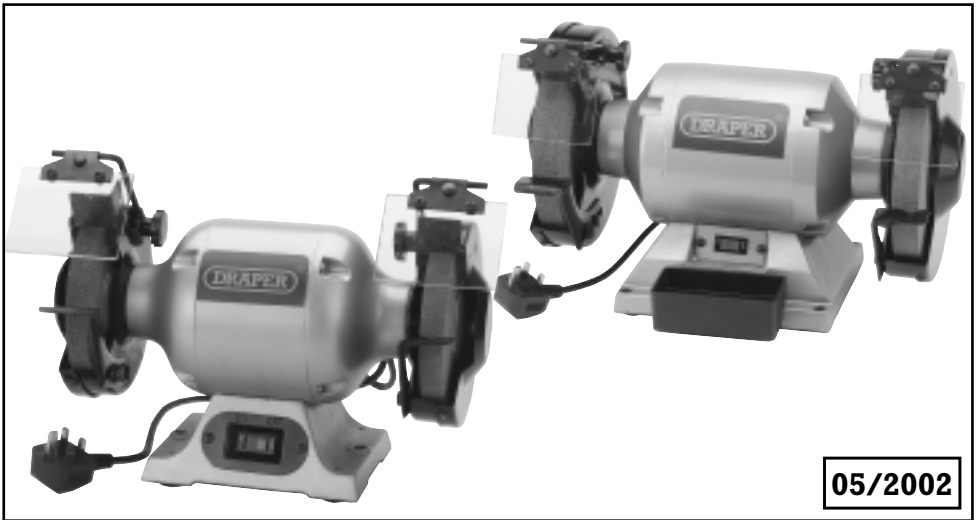

GENERAL INFORMATION

This manual has been compiled by Draper Tools and is an integrated part of the power tool equipment, which should be kept with the machine.

This manual describes the purpose for which this tool has been designed and contains all the necessary information to ensure its correct and safe use. We recommend that this manual is read before any operation of the machine, before performing any kind of adjustment to the machine, and prior to any maintenance tasks. By following all the general safety instructions contained in this manual, it will ensure both machine and operator safety, together with longer life of the tool itself.

All photographs and drawings in this manual are supplied by Draper Tools to help illustrate the operation of the machine.

Whilst every effort has been made to ensure accuracy of information contained in this manual, the Draper Tool policy of continuous improvement determines the right to make modifications without prior warning.

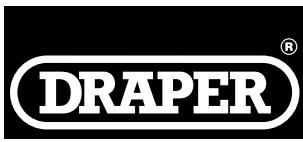

THE TOOL COMPANY

BENCH GRINDERS

■ STOCK No. 29620
29621

■ PART No. GHD150
GHD200

CONTENTS:

	Page No.
Contents/Declaration	1
Specification/Guarantee.....	2
Safety Warning	3
Additional Safety Rules/Power Supply	4
Getting to know your Bench Grinder	5
Unpacking	6
Assembly	7-8
Operating Instructions/Grinding Tips	9
Changing the Grinding Wheel	10
Accessories	11



DECLARATION OF CONFORMITY

We
Draper Tools Ltd. Hursley Road, Chandler's Ford, Eastleigh, Hampshire.
SO53 1YF. England.

Declare under our sole responsibility that the product:

Stock Nos:- 29620 & 29621.

Part Nos:- GHD150 & GHD200.

Description:- Bench Grinders.

To which this declaration relates is in conformity with the following directive(s)
98/37/EC, 73/23EEC & 89/336EEC.

With reference to: BSEN61029-1 & IEC1029-2-4.

JOHN DRAPER
Managing Director

17/09/2001



SPECIFICATION

The Draper Tools policy of continuous improvement determines the right to change specification without notice.

Part No.	GHD150	GHD200
Stock No.	29620	29621
Grinding Wheel Diameter	150mm (6")	200mm (8")
Bore Size	12.7mm (1/2")	16mm (5/8")
Width/Face	19mm (3/4")	25mm (1")
Speed	3000rpm	3000rpm
Power Output	370W (1/2 HP)	550W (3/4 HP)
Motor Voltage	230V~50Hz	230V~50Hz
Weight Nett/Gross	11kg/12kg	21kg/22kg
Dimensions	360x220x245mm	400x245x270mm

The typical sound pressure level of this tool is less than 70dbA.

ALWAYS WEAR EYE PROTECTION



GUARANTEE

Draper machine tools have been carefully tested and inspected before shipment and are guaranteed to be free from defective materials and workmanship for a period of 12 months from the date of purchase except where tools are hired out when the guarantee period is ninety days from the date of purchase.

Should the machine develop any fault, please return the complete tool to your nearest authorized warranty repair agent or contact Draper Tools Limited, Chandler's Ford, Eastleigh, Hampshire, SO53 1YF. England. Telephone (023) 8026 6355.

If upon inspection it is found that the fault occurring is due to defective materials or workmanship, repairs will be carried out free of charge. This guarantee does not apply to normal wear and tear, nor does it cover any damage caused by misuse, careless or unsafe handling, alterations, accident, or repairs attempted or made by any personnel other than the authorised Draper warranty repair agent.

This guarantee applies in lieu of any other guarantee expressed or implied and variations of its terms are not authorized.

Your Draper guarantee is not effective unless you can produce upon request a dated receipt or invoice to verify your proof of purchase within the 12 month period.

Please note that this guarantee is an additional benefit and does not affect your statutory rights.

Draper Tools Limited.

GENERAL SAFETY INSTRUCTIONS FOR POWER TOOLS

WARNING

Please read the following instructions carefully, failure to do so could lead to serious personal injury.

IMPORTANT

Draper Tools Limited recommends that this machine should not be modified or used for any application other than that for which it was designed. If you are unsure of its relative applications do not hesitate to contact us in writing and we will advise you.

1. KNOW YOUR POWER TOOL

Read and understand the owner's manual and labels affixed to the tool. Learn its application and limitations as well as the specific potential hazards peculiar to this tool.

2. KEEP WORK AREA CLEAN

Cluttered areas and benches invite accidents. Floors must not be slippery due to oil or sawdust.

3. AVOID DANGEROUS ENVIRONMENTS

Do not use power tools in damp or wet locations, or expose them to rain. Keep work area well lit. Provide adequate space surrounding the work area. Do not use in environments with a potentially explosive atmosphere.

4. KEEP CHILDREN AWAY

All visitors should be kept a safe distance from work area.

5. STORED TOOLS

When not being used, all tools should be stored in a dry, locked cupboard or out of the reach of children.

6. WEAR PROPER CLOTHING

Do not wear loose clothing, neckties or jewellery (rings, wristwatches) to catch in moving parts. NONSLIP footwear is recommended. Wear protective hair covering to contain long hair. Roll long sleeves above the elbow.

7. USE SAFETY GOGGLES (Head Protection)

Wear CE approved safety goggles at all times. Normal spectacles only have impact resistant lenses, they are NOT safety glasses. Also, use face or dust mask if application is dusty and ear protectors (plugs or muffs) during extended periods of operation.

8. NOISE LEVELS

Some types of machines may have high noise levels when working. In such cases ear protection must be worn.

9. VIBRATION LEVELS

Hand held power tools produce different vibration levels. You should always refer to the specifications and relevant Health and Safety guide.

10. DUST EXTRACTION

If your tool is fitted with a dust extraction fitting, always ensure that it is connected and being used with a dust extractor. Vacuum cleaners can be used if suitable for the material being extracted.

11. PROTECT YOURSELF FROM ELECTRIC SHOCK

When working with power tools, avoid contact with any earthed items (e.g. pipes, radiators, hobs and refrigerators, etc.). If you are using a power tool in extreme conditions (e.g. high humidity or generating metal dust), always use an RCD (residual current device) at the power socket.

12. STAY ALERT

Always watch what you are doing and use common sense. Do not operate a power tool when you are tired or under the influence of alcohol or drugs.

13. WHEN WORKING OUT OF DOORS

Only use extension leads designed for that purpose.

14. ACCESS TO MAINS SOCKET

If a stationary machine is fitted with a moulded plug and cable, the machine should not be positioned so that access to the mains socket is restricted.

15. DISCONNECT POWER TO THE TOOL

When not in use, before servicing and when changing accessories such as cutters, etc.

16. AVOID ACCIDENTAL STARTING

Make sure the switch is in the OFF position before plugging the machine into the power supply.

17. NEVER LEAVE MACHINE RUNNING UNATTENDED

Turn power off. Do not leave machine until it comes to a complete stop.

18. DO NOT ABUSE THE CORD

Never carry the tool by the power cable or pull it from the socket. Keep the power cable away from heat, oil and sharp edges.

19. NEVER STAND ON TOOL

Serious injury could occur if the tool is tipped or if the cutting tool is accidentally contacted. Do not store materials above or near the tool, so that it is necessary to stand on the tool to reach them.

20. CHECK DAMAGED PARTS

Check for damage to parts, breakage of parts, mountings and any other conditions that may affect its operation. A guard or other part that is damaged should be properly repaired or replaced.

21. KEEP GUARDS IN PLACE

And in working order.

22. MAINTAIN TOOLS WITH CARE

Keep tools sharp and clean for the best and safest performance. Follow instructions for lubricating and changing accessories. All extension cables must be checked at regular intervals and replaced if damaged. Always keep the hand grips on the tool clean, dry and free of oil and grease.

23. USE RECOMMENDED ACCESSORIES

Consult the owners manual for recommended accessories. Follow the instructions that accompany the accessories. The use of improper accessories may cause hazards.

24. REMOVE ADJUSTING KEYS AND WRENCHES

Form a habit of checking to see that keys and adjusting wrenches are removed from the tool before turning it on.

25. SECURE WORK

Use clamps or a vice to hold work. This frees both hands to operate the tool.

26. DO NOT OVERREACH

Keep proper footing and balance at all times.

27. USE RIGHT TOOL

Do not force the tool or attachment to do a job for which it was not designed.

28. DO NOT FORCE TOOL

It will do the job better and safer at the rate for which it was designed.

29. DIRECTION OF FEED

Feed work into a blade or cutter against the direction of rotation of the blade or cutter only.

30. WHEN DRILLING OR SCREWING INTO WALLS

Always make sure there is no danger of hitting any hidden power cables, water or gas pipes in the wall.

IMPORTANT NOTE

Residual Risk. Although the safety instructions and operating manuals for our tools contain extensive instructions on safe working with power tools, every power tool involves a certain residual risk which can not be completely excluded by safety mechanisms. Power tools must therefore always be operated with caution !



ADDITIONAL SAFETY RULES FOR BENCH GRINDERS

FOR YOUR OWN SAFETY:



Reading and understand the instruction manual before operation.

1. Always wear eye protection which complies to a recognised standard.
2. Wear a mask or respirator when dust is generated.
3. Tighten grinding wheel lock nuts, securing bolts and all clamps and guards.
4. Keep guards in place and working properly.
5. Keep hand clear of grinding wheels.
6. Never reach behind or beneath the grinding wheels.
7. Unplug from power supply before adjusting or servicing.
8. To avoid electric shock do not use in damp conditions or expose to rain.
9. When fitting a new grinding wheel, always check that the stated max. grinding wheel for damage such as flaws or cracks, then if the wheel appears satisfactory fit the new wheel to the grinder.
10. When a new grinding wheel has been fitted stand to one side of the grinder and switch 'ON'. Let the grinder operate at full speed for approximately one minute so that any undetected flaws or cracks will become apparent.
11. Do not attempt to cut anything with the grinding wheel.



POWER SUPPLY

CONNECTING YOUR MACHINE TO THE POWER SUPPLY: (230V ONLY)

To eliminate the possibility of an electric shock, your machine has been fitted with a BS approved, non-rewirable moulded plug and cable which incorporates a fuse, the value of which is 3 amps. Should the fuse need to be replaced, an  approved BS1362 fuse must be used of the same rating, marked thus . The fuse cover is detachable, never use the plug with the cover omitted. If a replacement fuse cover is required, ensure it is of the same colour as that visible on the pin face of the plug (i.e. red). Fuse covers are available from your Draper Tools stockist. If the fitted plug is not suitable, it should be cut off and destroyed. *The end of the cable should now be suitably prepared and the correct type of plug fitted. See below.

WARNING:

A plug with bare flexible wires exposed is hazardous if engaged in a live power socket outlet.

WARNING: THIS APPLIANCE MUST BE EARTHED.

Green and Yellow - Earth, Blue - Neutral, Brown - Live.

As these colours may not correspond with the coloured markings identifying the terminals in your plug, proceed as follows:

The wire which is coloured green and yellow must be connected to the terminal in the plug which is marked with the letter 'E' or by the earth symbol  or coloured green or green and yellow.

The wire which is coloured blue must be connected to the terminal which is marked with the letter 'N' or coloured black or blue.

The wire which is coloured brown must be connected to the terminal which is marked with the letter 'L' or coloured red or brown.

EXTENSION LEAD CHART:

Extension lead sizes shown assure a voltage drop of not more than 5% at rated load of tool.

Ampere rating (on name plate)	3	6	10	13
Extension cable length	Wire size mm ²			
7.5	0.75	0.75	1.0	1.25
15m	0.75	0.75	1.0	1.5
22.5m	0.75	0.75	1.0	1.5
30m	0.75	0.75	1.25	1.5
45m	0.75	1.25	1.5	2.5

GETTING TO KNOW YOUR BENCH GRINDER

Fig.1.
GHD200

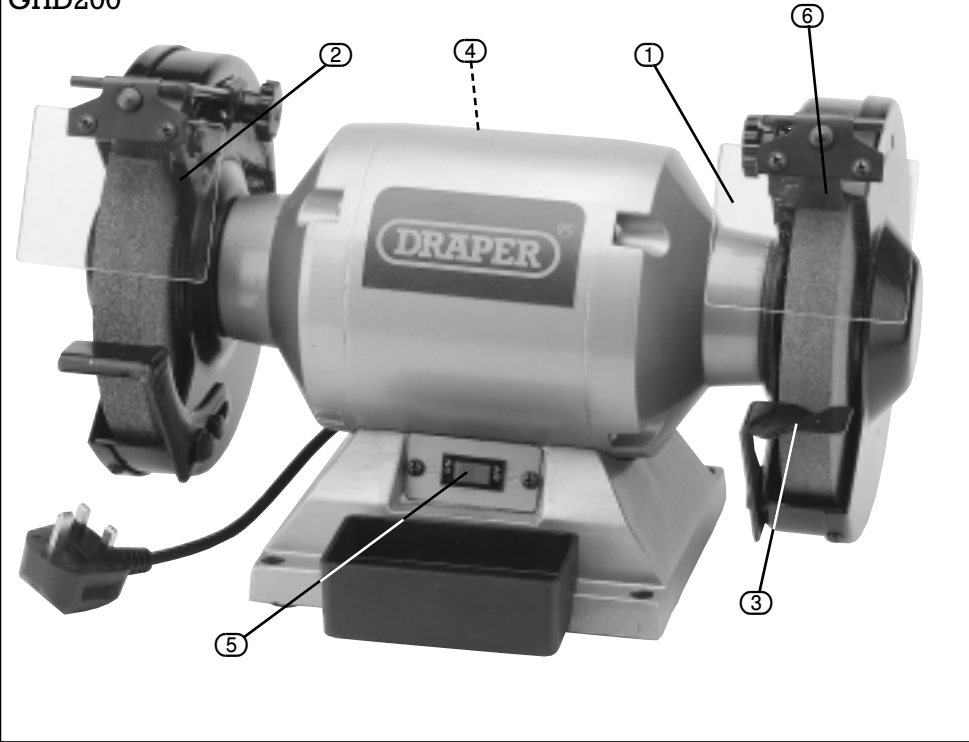

Fig.1.

- 1. Eyeshields
- 2. Wheel Guards
- 3. Tool Rests

- 4. Rating Plate (Reverse)
- 5. "ON/OFF" Switch
- 6. Spark Deflector

UNPACKING

Carefully unpack the bench grinder and all the loose parts from the carton. Fig. 2. illustrates the bench grinder and all the associated parts. Carefully check that all the parts are present.

Fig.2.
GHD150



ASSEMBLY

To correctly assemble, fit and adjust the tool rests, spark deflectors and eye shields.

Carefully follow these instructions:

TOOL RESTS.

Attach the left and right hand tool rests (A) using the four bolts (B) and large washers (C) as shown in Fig.3. Now adjust the tool rests so there is approximately a 1.5mm ($\frac{1}{16}$ ") gap between the surface of the grinding wheels and the tool rests.

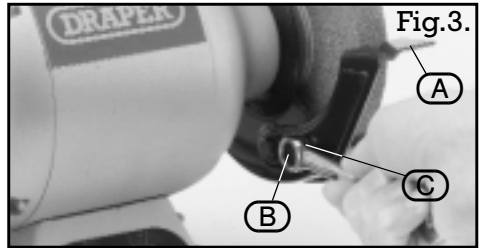

SPARK DEFLECTORS

Attach the two spark deflectors (D) using the two bolts (E) and medium size washers (F) as shown in Fig.4. Now adjust the spark deflectors so there is approximately a 1.5mm ($\frac{1}{16}$ ") gap between the surface of the grinding wheels and spark deflectors.

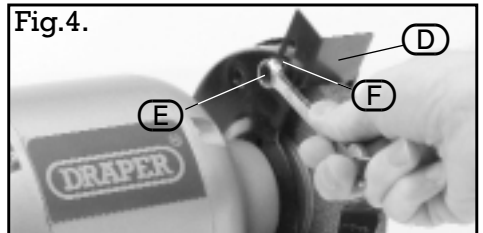

EYE SHIELDS

Place the eye shield frame (G) over the eye shield (H) fasten the two parts together using the long screws (I), washers (J) and nuts (K). See Fig. 5.

Note: Do not overtighten as the eye shield may crack.

Assemble the other eyeshield in the same way.

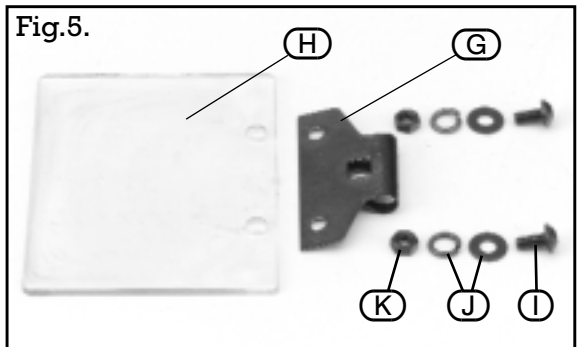

Insert the shortest end of the mounting rod (L) Fig.6 into the hole (M) in the shield frame (N). Now tighten the nut (O) and round headed bolt which are located in the centre of each of the eye shield mounting frames (P). Fig.7 shows the assembled eye shield assembly.

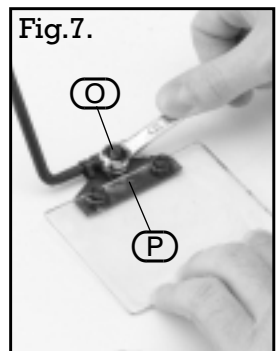
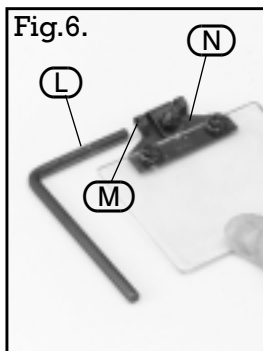

ASSEMBLY

To fit the eye shields to the bench grinder attach clamp (Q) to the wheel guard using lock knob (R) large star washer (S) and large washer (T) as shown in Fig.8. Insert mounting rod (U) into the clamp (Q), position as required and tighten lock knob (R). The eye shield is fully adjustable. It can be adjusted by either loosening the lock knob (R) and moving the rod (U) or by moving the eye shields.

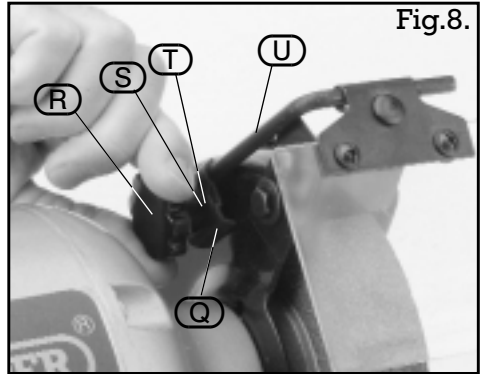

ATTACHING THE COOLING TROUGH (GHD200 ONLY)

Attach the cooling trough to the bench grinder by inserting the lug on the bottom of the tray into the hole in the base at the front of the bench grinder. See Fig.9.

Fastening the Bench Grinder to a Bench

Securely bolt the bench grinder to a workbench through the two holes (GHD200 - four holes), in the base of the machine. Ensure there is enough clear area around the grinder to accommodate larger items which may be ground, ie. garden tools, etc.

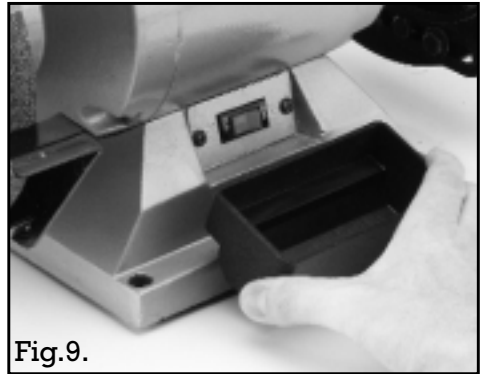



OPERATING INSTRUCTIONS

A bench grinder is designed for hand grinding operations only, such as sharpening drill bits, chisels and screwdrivers or removing excess metal from workpieces.

A coarse grit grinding wheel could be used for grinding rough metals, to remove large amounts of metal, or where a smooth finish is not important.

A fine grit grinding wheel could be used for sharpening tools or grinding close to size. A fine grit wheel removes a metal more slowly and therefore gives the workpiece a smooth finish and does not generate enough heat to anneal the cutting edges.

1. Check that there is a 1.5mm ($\frac{1}{16}$ ") clearance between the tool rests and the surface of the grinding wheels. Adjust as necessary. Now check the gap between the spark deflectors and the surface of the grinding wheels. These should also be 1.5mm ($\frac{1}{16}$ "). Adjust as necessary.

The tool rests should be adjusted so that they are just below the centre line of the grinding wheels. This should help prevent accidental jamming of the work between the tool rest and the wheel.

2. Check that the eye shields have been secured in the correct position and that the grinding wheel lock nuts are tight.

NOTE: Before fitting a new grinding wheel to the bench grinder always carefully check the wheel for damage such as chips, flaws or cracks. Then if the new wheel appears to be satisfactory fit the wheel to the grinder. Stand to one side of the grinder and switch "ON". Let the grinder operate at full speed for approximately one minute so that any undetected cracks or flaws in the wheel will become apparent.

3. Stand to one side of the bench grinder, switch on and let it build up to full speed.
4. When grinding, always keep the workpiece moving across the face of the wheel. Grinding against the same part of the wheel will cause uneven wear of the wheel face.
5. When necessary redress the grinding wheels using a wheel dressing tool. After redressing adjust the tool rests and spark deflectors as necessary to maintain a 1.5mm ($\frac{1}{16}$ ") clearance from the wheel.



GRINDING TIPS

1. Ensure that the item to be ground is comfortably and securely held.
2. Adjust tool rest to correct angle.
3. Present the workpiece smoothly on to the grinding wheel face with a light and even pressure.
4. Grind against the edge of the workpiece to avoid burrs.
5. Never grind on the sides of the wheels.
6. Best results are achieved if the grinder is allowed to rotate at its maximum speed. Excess pressure from the workpiece can damage the wheel and overload the motor.
7. Check grinding wheels regularly for wear or damage. Replace wheels that are worn more than 25%. Damaged wheels should be discarded immediately as they are dangerous and can cause the grinder to vibrate.
8. After grinding fine edge tools, they should be honed by hand on a fine slip stone.



CHANGING THE GRINDING WHEELS

1. Switch the bench grinder "OFF" and disconnect from the power supply.
2. Remove the screws which secure the grinding wheel side covers then take off covers.
3. Either, hold the opposite wheel firmly and remove the nut and flange, or place a wedge between the grinding wheel and the wheel guard, then remove the nut and flange.
NOTE: the left hand grinding wheel nut has a left thread.
4. When fitting a new grinding wheel always check that the stated max. grinding wheel RPM exceeds the RPM of the bench grinder. Also check the grinding wheel for damage such as flaws or cracks, then if the wheel appears satisfactory fit the new wheel to the grinder.
5. Remove the old wheel and replace it with the new one.
6. Place the flange on the spindle and tighten the spindle nut just enough to hold the wheel firmly. **Do not over tighten the nut as the wheel may become damaged.** Repeat the above to replace the opposite wheel.
7. Re-assemble the side covers.
8. Stand to one side of the grinder and switch "ON". Let the grinder operate at full speed for approximately one minute so that any undetected cracks or flaws in the wheel will become apparent.



ACCESSORIES

The following accessories are available from your local Draper Stockist.

GRINDING WHEELS.

Stock No.:29629
 Part No.:AG150F
 Type Grit:Fine 60
 Diameter:150mm
 Bore size:12.7mm
 Width (Face size):19mm

Stock No.:29630
 Part No.:AG150C
 Type Grit:Coarse 36
 Diameter:150mm
 Bore size:12.7mm
 Width (Face size):19mm

Stock No.:36298
 Part No.:AG150G
 Type Grit:Green
 Diameter:150mm
 Bore size:12.7mm
 Width (Face size):19mm
 Note: Suitable for grinding T.C.T.

Stock No.:29631
 Part No.:AG200F
 Type Grit:Fine 60
 Diameter:200mm
 Bore size:16mm
 Width (Face size):25mm

Stock No.:29632
 Part No.:AG200C
 Type Grit:Coarse 36
 Diameter:200mm
 Bore size:16mm
 Width (Face size):25mm

Stock No.:36299
 Part No.:AG200G
 Type Grit:Green
 Diameter:200mm
 Bore size:16mm
 Width (Face size):25mm
 Note: Suitable for grinding T.C.T.

GENERAL ACCESSORIES

Stock No.:30479
 Part No.:AG100
 Description:Grinding Wheel Dresser
 Length:150mm

Stock No.:30634
 Part No.:YAG100
 Description:Spare Cutters

Stock No.:30635
 Part No.:YAG100
 Description:Spare Pin

Stock No.:10751
 Part No.:1180
 Description:Drill Grinding Attachment

WIRE WHEELS

Stock No.:33879
 Part No.:AGW6C
 Diameter:150mm
 Bore size:12.7mm
 Width (Face size):19mm



NOTES



<h1>NOTES</h1>



NOTES

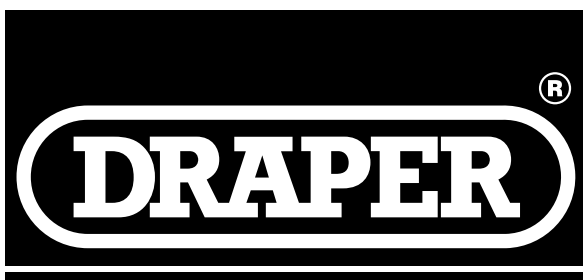

THE TOOL COMPANY

DRAPER TOOLS LIMITED,

Hursley Road, Chandler's Ford, Eastleigh, Hants. SO53 1YF. U.K.

Helpline: (023) 8049 4344.

Sales Desk: (023) 8049 4333.

General Enquiries: (023) 8026 6355.

Fax: (023) 8026 0784.



www.draper.co.uk

e-mail: sales@draper.co.uk

YOUR DRAPER STOCKIST

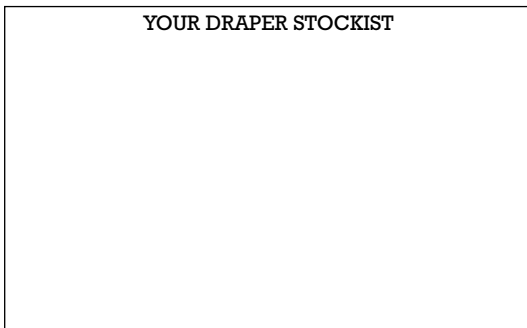

©Published by Draper Tools Ltd.

No part of this publication may be reproduced, stored in a retrieval system or transmitted in any form or by any means, electronic, mechanical photocopying, recording or otherwise without prior permission in writing from Draper Tools Ltd.