

# Clariflo®



WARNING: Read the instructions before using the machine.

## POWER WASHER

### MODEL NO: JETSTAR 1950

PART NO: 7336010

## OPERATION & MAINTENANCE INSTRUCTIONS



ORIGINAL INSTRUCTIONS

LS0617 - ISS 3

---

## INTRODUCTION

---

Thank you for purchasing this CLARKE Power Washer.

This pressure washer is designed for cleaning machines, vehicles, buildings, boats, facades, terraces, gardening tools, etc. by means of a high-pressure water jet (if necessary, with additional cleaning agents).

Only use accessories, replacement parts and cleaning agents recommended by Clarke international.

Before attempting to use this product, please read this manual thoroughly.

---

## GUARANTEE

---

This product is guaranteed against faulty manufacture for a period of 12 months from the date of purchase. Please keep your receipt which will be required as proof of purchase.

This guarantee is invalid if the product is found to have been abused or tampered with in any way, or not used for the purpose for which it was intended.

Faulty goods should be returned to their place of purchase, no product can be returned to us without prior permission.

This guarantee does not effect your statutory rights.

---

## LIST OF CONTENTS

---

The following items should be supplied in the carton. If any parts are missing or damaged, please see your Clarke dealer where you purchased the machine.

1 x Pressure Washer (with integral detergent tank)	1 x Inlet Filter (installed)
1 x Gun Assembly	1 x Pair of Storage Brackets
1 x Lance & Nozzle assembly (with High/Low & Pencil Jet/Fan settings)	1 x Manual
1 x High Pressure (outlet) Hose	1 x Nozzle Cleaning Pin
1 x Inlet Hose Adaptor (fitted)	

---

# GENERAL SAFETY RULES

---



**WARNING: WATER AT HIGH PRESSURE CAN BE DANGEROUS AND CAN CAUSE DAMAGE IF THE OPERATOR IS CARELESS. NEVER ALLOW ANYONE TO OPERATE THIS PRESSURE WASHER UNLESS THEY ARE FAMILIAR WITH THE SAFETY PRECAUTIONS.**

---

1. **NEVER** direct the spray towards any person or animal.
2. **NEVER** direct the spray towards electrical wiring or equipment.
3. **NEVER** hold your finger over the high pressure nozzle.
4. **NEVER** allow children or untrained personnel to use this machine.
5. **NEVER** operate the machine with any of the covers removed.
6. **NEVER** attempt any repairs to this machine. Always refer to your Clarke dealer.
7. **NEVER** supply any liquid other than water to the water inlet.
8. **NEVER** use the detergent bottle to introduce flammable liquids/solvents, e.g. paint thinners, petrol, oil as there is a risk of explosion.
9. **NEVER** direct the jet at electrical equipment or the machine itself.
10. **NEVER** use the pressure washer if the supply cable or important parts of the machine are damaged.
11. **ALWAYS** release any residual pressure in the system by turning off the water supply and operating the trigger before disconnecting any hose or accessory.
12. **ALWAYS** keep the machine itself dry and well clear of water spray.
13. **ALWAYS** wear protective clothing and safety glasses. Loose particles and other debris may be propelled at high speed by the water jet.
14. **ALWAYS** grip the gun firmly and expect the spray gun to 'kick' when starting.
15. **ALWAYS** respect the requirements of the local water company. Pressure washers may only be connected to the mains drinking water supply, if a system separator (known as a backflow preventer) is installed in the supply hose.
16. **ALWAYS** disconnect from the water supply, and ensure the system is completely drained when not in use. Store in a cool dry location.
17. **ONLY** use chemical cleaning agents (detergents), that are approved for pressure washers. CLARKE Traffic Film Remover or CLARKE Wash and Wax (available from your dealer), is recommended.
18. **WARNING:** High pressure water jets can be dangerous if subject to misuse. The jet must not be directed at a person or anything that they are wearing.
19. **WARNING:** High pressure hoses, fittings and couplings are important for the safety of the machine. Use only hoses, fittings and couplings recommended by the manufacturer.
20. **WARNING:** Water that has flowed through a system separator (known as a backflow preventer) is considered non-drinkable.

## ENVIRONMENTAL RECYCLING POLICY



Through purchase of this product, the customer is taking on the obligation to deal with the WEEE in accordance with the WEEE regulations in relation to the treatment, recycling & recovery and environmentally sound disposal of the WEEE.

In effect, this means that this product must not be disposed of with general household waste. It must be disposed of according to the laws governing Waste Electrical and Electronic Equipment (WEEE) at a recognised disposal facility.

## SYMBOLS ON THE MACHINE

	<p>Read the manual before use.</p>		<p>Failing to follow these instructions could result in injury or damage to the machine.</p>
	<p>Conforms to CE Regulations.</p>		<p>Wear safety glasses when using this machine.</p>
			<p>The high pressure jet must not be directed at persons, animals, live electrical equipment or at the appliance itself.</p>

# ELECTRICAL CONNECTIONS



**WARNING: READ THESE ELECTRICAL SAFETY INSTRUCTIONS THOROUGHLY BEFORE CONNECTING THE PRODUCT TO THE MAINS SUPPLY.**

Before switching the product on, make sure that the voltage of your electricity supply is the same as that indicated on the rating plate. Connecting it to any other power source may cause damage.

If it is necessary to change the fuse in the plug, the fuse cover must be refitted. If the fuse cover becomes lost or damaged, the plug must not be used until a suitable replacement is obtained.

If the plug has to be changed due to damage, a replacement should be fitted, following the wiring instructions shown below. The old plug must be disposed of as insertion into a mains socket could cause an electrical hazard.



**WARNING: THE WIRES IN THE POWER CABLE OF THIS PRODUCT ARE COLOURED IN ACCORDANCE WITH THE FOLLOWING CODE:  
BLUE = NEUTRAL    BROWN = LIVE**

If the colours of the wires in the power cable of this product do not correspond with the markings on the terminals of your plug, proceed as follows.

- The wire which is coloured **Blue** must be connected to the terminal which is marked **N** or coloured **Black**.
- The wire which is coloured **Brown** must be connected to the terminal which is marked **L** or coloured **Red**.

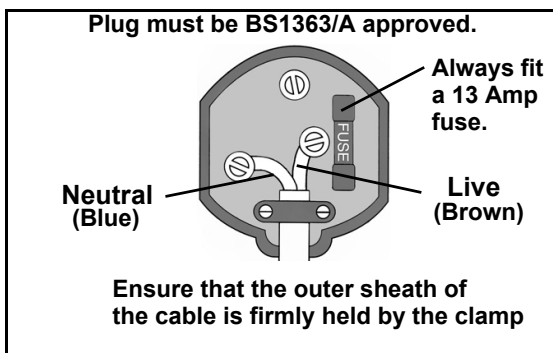

**We strongly recommend that this machine is connected to the mains supply via a Residual Current Device (RCD) that will interrupt the supply if the leakage current to earth exceeds 30 mA for 30 ms**

If in any doubt, consult a qualified electrician. DO NOT attempt any repairs yourself.



This symbol indicates that this is a Class II product, and does not require an earth connection.

# OVERVIEW



1	Spray Gun Assembly	4	ON/OFF Switch
2	Lance	5	High Pressure Hose
3	Detergent Bottle	6	High Pressure Hose Connection Point

## ASSEMBLY

1. Slide the brackets into their positions.
  - They will 'click' into place.
2. Connect the high pressure hose to the pressure washer as shown and tighten securely.
3. Insert the hose into the gun fully
4. Slide the hose clip towards the hose to lock in place.
5. Insert the lance into the gun as shown and twist to lock in place.

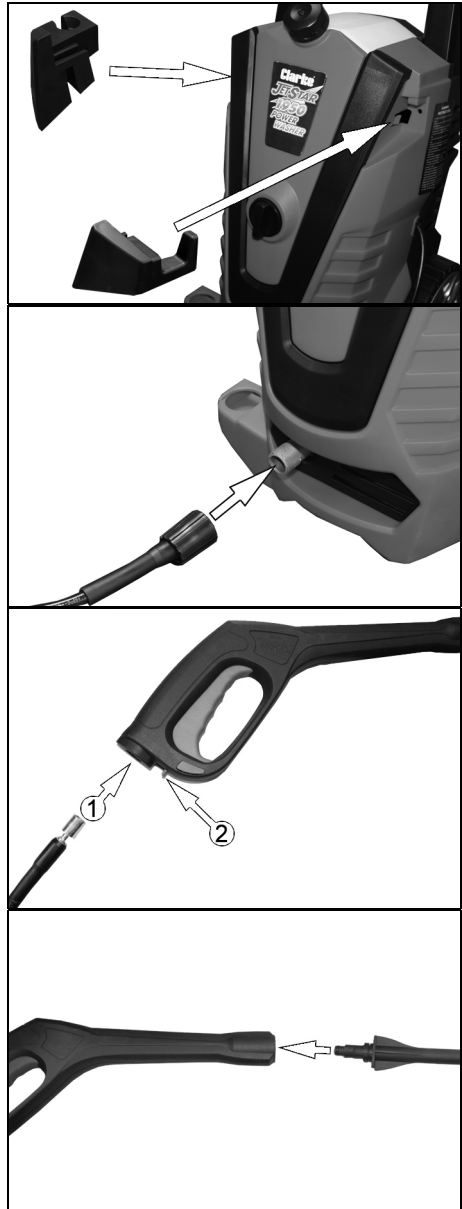

---

## CONNECTING THE MAINS WATER SUPPLY

---

**NOTE:** Always follow the regulations of your local water supplier.

1. Screw the inlet adaptor to the water inlet as shown.
2. Connect the supply hose to the inlet adaptor.

- A standard garden hose or a reinforced hose with an inner diameter of at least 10 mm available from your CLARKE dealer will be suitable.

3. Connect the supply hose to the water supply.

- The water supply must provide a minimum of 6.5 litres per minute at a maximum of 40°C.

4. Open the water tap fully.

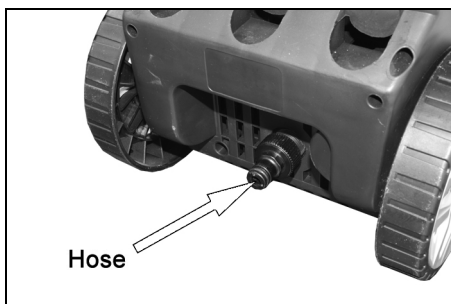

---

## OPERATION

---

1. Turn the water supply on, making sure that the tap is fully open.



**WARNING: FAILURE TO TURN ON THE WATER FULLY COULD CAUSE DAMAGE TO THE POWER WASHER INTERNAL COMPONENTS.**

**WARNING: DO NOT USE THE POWER WASHER IF THE SUPPLY CABLE OR IMPORTANT PARTS OF THE MACHINE ARE DAMAGED, E.G. SAFETY DEVICES, HIGH PRESSURE HOSES, TRIGGER.**

**WARNING: WE RECOMMEND THAT THIS MACHINE IS CONNECTED TO THE MAINS SUPPLY VIA A RESIDUAL CURRENT DEVICE (RCD).**

2. Plug the mains power cable into the electricity supply.
3. Set the switch to the ON position.





4. Release the trigger lock.
  - The pressure washer is now ready for use.
5. Make sure that you have a firm footing and are also holding the gun and spray lance firmly.
  - Expect the spray gun to 'kick' when starting.

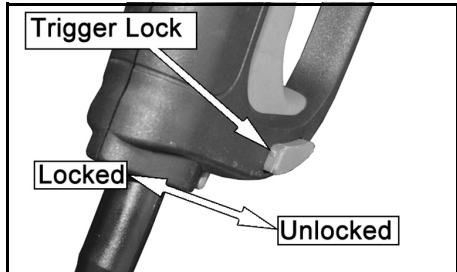

6. Pull the trigger on the gun to start water flow.
  - If you release the trigger the device will switch off again, the system remains under high pressure.
  - During longer breaks (more than 5 minutes), turn the pressure washer off. See "Shutting Down" on page 11.
7. Once the machine has been turned off, release any residual pressure in the system by turning off the water supply and operating the trigger before disconnecting any hose or accessory.

## ADJUSTMENTS

### TO CHANGE THE SPRAY PATTERN (NARROW JET / WIDE SPRAY)

1. Hold the shaft of the lance in one hand.
2. To vary the spray between narrow and wide, turn the nozzle counter-clockwise through a half-a-turn (180°).

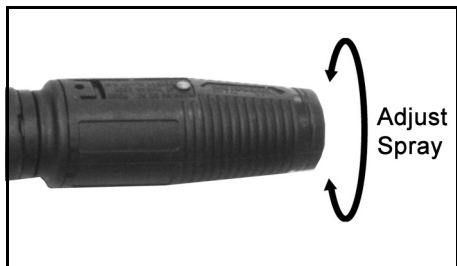

### ADJUSTING THE PRESSURE

Hold the rear of the nozzle and slide the front of the nozzle forwards for low pressure and backwards for high pressure.

Other ways to adjust the pressure include increasing the distance you are from the surface being cleaned and adjusting the spray to a wider angle (lowers the pressure).

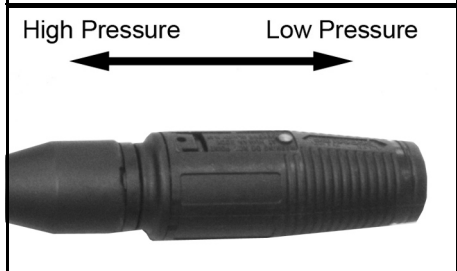

# APPLYING CHEMICALS AND CLEANING AGENTS

To improve the cleaning performance, you can introduce chemical cleaning agents (detergents) to the water jet using the detergent tank. This is particularly useful when washing cars, greasy engine parts, or removing oil spots on concrete etc.



**CAUTION: IF YOUR EYES COME INTO CONTACT WITH ANY CLEANING FLUIDS, RINSE THEM IMMEDIATELY WITH PLENTY OF FRESH CLEAN WATER AND SEEK MEDICAL ADVICE IF REQUIRED.**

## To prepare for detergent application:

1. Remove the detergent filler cap and fill the tank with detergent.
  - Only use detergents recommended for use with pressure washers such as CLARKE Traffic Film Remover for car cleaning, patio cleaning etc., or CLARKE Wash & Wax, both available from your CLARKE dealer.



DESCRIPTION	SIZE	PART NUMBER
Car Wash & Wax Shampoo	5 Litre	3050815
Concentrated Traffic Film Remover	5 Litre	3050821
Concentrated Traffic Film Remover	25 Litre	3050820
Ready To Use Traffic Film Remover	5 Litre	3050818
Ready To Use Traffic Film Remover	25 Litre	3050819

2. Replace the cap.
3. Slide the nozzle forwards to low pressure.
4. Use the pressure washer as normal.

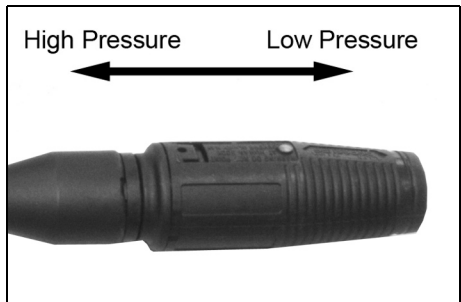

## SHUTTING DOWN

When you have finished using the pressure washer, follow the procedure shown below to switch off and disconnect the unit.

1. Set the switch to the OFF position.
2. Turn off the water supply at the tap.
  - To release the pressure in the machine, pull and hold the trigger until no more water comes out of the nozzle.
3. Engage the trigger lock.
4. Disconnect from the power supply.
5. Wind the hose onto the reel and put the spray gun/lance into the holder on the power washer.

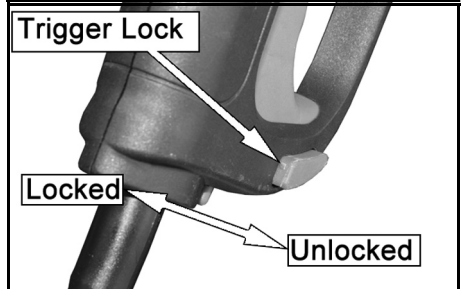

## STORAGE PROCEDURE

Disconnect from the water supply, and ensure the system is completely drained when not in use.

Store in a cool dry location.

Avoid storing the power washer at freezing temperatures.

**Residual water in the high pressure pump of hose assembly may cause permanent damage to the components if it freezes.**

---

# MAINTENANCE

---



**WARNING: REMOVE THE PLUG FROM THE SOCKET-OUTLET BEFORE CLEANING OR MAINTENANCE AND WHEN REPLACING PARTS**

---

## CLEANING THE NOZZLE

If the nozzle becomes partially clogged with foreign material such as dirt or limescale, excessive pressure may develop and the pump pressure will pulsate. Clean the nozzle immediately as follows:

1. Turn off the power washer and turn off the water supply.
2. Pull the trigger to relieve any water pressure.
3. Disconnect the lance from the spray gun.
4. Remove any obstructions by directing the water supply into the end of the lance for 30 seconds to back flush loose particles.
5. If flushing does not dislodge the obstruction, carefully use the nozzle cleaning tool, to clear the nozzle.
6. Reconnect the lance to the gun and turn on the water supply



## CLEANING THE WATER INLET FILTER

This filter should be checked periodically and cleaned if necessary.

1. Remove the inlet filter from the pressure washer as shown.
2. Clean the filter by flushing both sides with water.
3. Replace the filter into the water inlet.
  - The tapered side faces in.

**NOTE:** Do not operate the pressure washer without the filter installed.

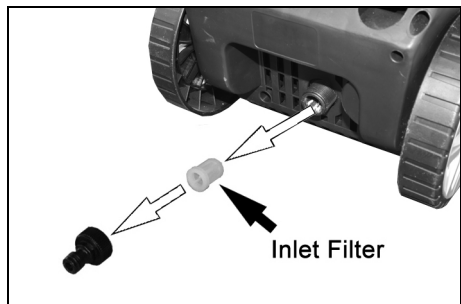

# TROUBLESHOOTING

<b>PROBLEM</b>	<b>POSSIBLE CAUSE</b>	<b>SOLUTION</b>
No water delivery.	Water filter blocked.	See cleaning the water filter.
	Clogged lance nozzle.	Clean the nozzle.
Low or irregular pressure.	Insufficient water supply.	Check connections.
	Pump taking in air.	Check connections.
	Detergent inlet sucking in air.	Check connections and that detergent supply is topped up.
	Water filter dirty.	Clean or replace.
	Water temperature is too high	Make sure the water supply is below 40 degrees.
Motor suddenly stops.	Thermal protection has activated due to overheating.	Switch off the machine and wait until the unit has cooled down sufficiently.
Pressure fluctuations or pressure drop.	Shortage of water.	Turn water tap on fully.
	No water due to clogged inlet filter.	Clean water inlet filter.
Motor does not start when switched on.	Plug is not connected properly.	Check plug and lead and have them replaced by a qualified electrician if necessary.
	Mains fuse tripped/blown.	Renew fuse or reset.
Motor hums when trigger operated and does not start.	Mains voltage too low.	Have electrical connection checked.
Motor cuts out.	Motor protection switch has been activated.	Switch off and allow to cool for at least 15 minutes.
	Nozzle partly clogged.	Clean using the supplied nozzle cleaning needle.
Additives are not being supplied.	Detergent container is empty.	Fill detergent container.
	High Pressure is selected.	Set the lance to LOW pressure.

---

## PRODUCT SPECIFICATIONS

---

<b>Model Number</b>	<b>JETSTAR 1950</b>
Part Number	7336010
Voltage	230V/50Hz
Motor Input Power	1600 W
Duty Cycle	S1 Continuous
Working pressure	90 bar
Maximum pump pressure	135 bar
Maximum output flow rate	6.5 l/min
Maximum input temperature	40°C
Detergent tank capacity	0.5 l
Sound Pressure Level ( $L_{pA}$ )	91
Sound Power level ( $L_{WA}$ )	93
Guaranteed sound power level ( $L_{WA}$ )	96
Sound Uncertainty Factor K	3
Vibration	2.8 m/s <sup>2</sup>
Uncertainty Factor K	1.5
Dimensions (L x W x H)	287 x 322 x 555 mm
Weight	8.4 kg

# DECLARATION OF CONFORMITY



**Clarke**  
INTERNATIONAL  
Hemholtz Street, Epping, Essex, CM16 4LG

## DECLARATION OF CONFORMITY

This is an important document and should be retained.

**Product Description:** Power Washer  
**Model number(s):** Jetstar 1950  
**Serial / batch Number:** 73360010  
**Date of Issue:** 02/06/2017  
**(Noise Conformity)**  
**Notified Body:** n/a

**Technical Documentation Holder:** A.R. Pond  
Clarke International  
Za Shrubland Road  
London E10 7RB  
UK

**Conformity Assessment Procedure:** to 2000/14/EC Annex V  
**Manufacturer:** Clarke International  
**Noise Related Value:** 400 L/h  
**Measured Sound Power Level:** 93 dB  
**Guaranteed Sound Power Level:** 96 dB

01-06-2017 JETSTAR 1950 Pressure washer DOC(n-2)

Page 1 of 2



**Clarke**  
INTERNATIONAL  
Hemholtz Street, Epping, Essex, CM16 4LG

## DECLARATION OF CONFORMITY

This is an important document and should be retained.

**We hereby declare that this product(s) complies with the following directive(s):**  
2014/30/EU Electromagnetic Compatibility Directive.  
2006/42/EC Machinery Directive.  
2011/65/EU Restriction of Hazardous substances  
2000/14/EC Noise Emissions Directive, (amended by 2005/68/EC).

**The following standards have been applied to the product(s):**  
EN 60335-1:2012+A11:2014, EN 60335-2-79:2012, EN 62233:2008, EN 55014-2:2015,  
EN 55014-1:2006+A1:2009+A2:2011, EN 61000-3-2:2014, EN 61000-3-3:2013.

This technical documentation required to demonstrate that the product(s) meet(s) the requirement(s) of the aforementioned directive(s) has been compiled and is available for inspection by the relevant enforcement authorities.

The CE mark was first applied in: 2017

Signed:

  
J.A. Clarke  
Director

01-06-2017 JETSTAR 1950 Pressure washer DOC(n-2)

Page 2 of 2

# A SELECTION FROM THE VAST RANGE OF

# Clarke®

## QUALITY PRODUCTS

### AIR COMPRESSORS

From DIY to industrial, Plus air tools, spray guns and accessories.

### GENERATORS

Prime duty or emergency standby for business, home and leisure.

### POWER WASHERS

Hot and cold, electric and engine driven - we have what you need

### WELDERS

Mig, Arc, Tig and Spot. From DIY to auto/industrial.

### METALWORKING

Drills, grinders and saws for DIY and professional use.

### WOODWORKING

Saws, sanders, lathes, mortisers and dust extraction.

### HYDRAULICS

Cranes, body repair kits, transmission jacks for all types of workshop use.

### WATER PUMPS

Submersible, electric and engine driven for DIY, agriculture and industry.

### POWERTOOLS

Angle grinders, cordless drill sets, saws and sanders.

### STARTERS/CHARGERS

All sizes for car and commercial use.



**PARTS & SERVICE: 0208 988 7400**

**E-mail: [Parts@clarkeinternational.com](mailto:Parts@clarkeinternational.com) or [Service@clarkeinternational.com](mailto:Service@clarkeinternational.com)**

**SALES: UK 01992 565333 or Export 00 44 (0)1992 565335**

**Clarke® INTERNATIONAL** Hemnall Street, Epping, Essex CM16 4LG  
[www.clarkeinternational.com](http://www.clarkeinternational.com)