

BGA 45

STIHL



2 - 14 Instruction Manual



Contents

1	Introduction.....	2
2	Guide to Using this Manual.....	2
3	Overview.....	2
4	Safety Precautions.....	3
5	Preparing the Blower for Operation.....	8
6	Charging the Blower, LEDs.....	9
7	Assembling the Blower.....	9
8	Inserting and Removing Activation Key....	10
9	Switching the Blower On/Off.....	10
10	Testing the Blower and Battery.....	10
11	Operating the Blower.....	11
12	After Finishing Work.....	11
13	Transporting.....	11
14	Storing.....	11
15	Cleaning.....	12
16	Maintenance and Repairs.....	12
17	Troubleshooting.....	12
18	Specifications.....	12
19	Spare Parts and Accessories.....	13
20	Disposal.....	13
21	EC Declaration of Conformity.....	13
22	UKCA Declaration of Conformity.....	14

1 Introduction

Dear Customer,

Thank you for choosing STIHL. We develop and manufacture our quality products to meet our customers' requirements. The products are designed for reliability even under extreme conditions.

STIHL also stands for premium service quality. Our dealers guarantee competent advice and instruction as well as comprehensive service support.

STIHL expressly commit themselves to a sustainable and responsible handling of natural resources. This user manual is intended to help you use your STIHL product safely and in an environmentally friendly manner over a long service life.

We thank you for your confidence in us and hope you will enjoy working with your STIHL product.

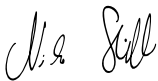

Dr. Nikolas Stihl

**IMPORTANT! READ BEFORE USING AND
KEEP IN A SAFE PLACE FOR REFERENCE.**

2 Guide to Using this Manual

2.1 Applicable Documentation

Local safety regulations apply.

- ▶ Read, understand and save the following documents in addition to this instruction manual:
 - Safety information for STIHL batteries and products with built in batteries:
www.stihl.com/safety-data-sheets

2.2 Symbols used with warnings in the text

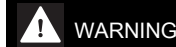

- This symbol indicates dangers that can cause serious injuries or death.
 - ▶ The measures indicated can avoid serious injuries or death.



- This symbol indicates dangers that can cause damage to property.
 - ▶ The measures indicated can avoid damage to property.

2.3 Symbols in Text



- This symbol refers to a chapter in this instruction manual.

3 Overview

3.1 Blower and Charging Cable

The rechargeable battery is built into the blower.

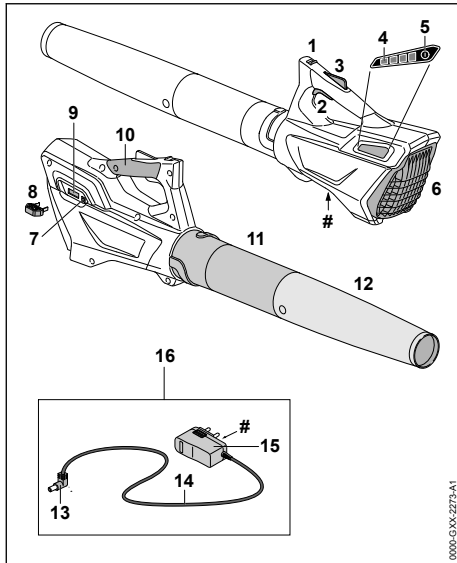

- 1 Release Slide**
Operated together with the trigger lockout to unlock the trigger.
- 2 Trigger**
The trigger switches the blower on and off.
- 3 Trigger Lockout**
Locks trigger in position.
- 4 LEDs**
Indicate blower's state of charge and malfunctions.
- 5 Button**
Activates the LEDs on the blower.
- 6 Intake Screen**
Protects the operator from moving parts inside the blower.
- 7 Charging Socket**
Accommodates the charger plug.
- 8 Activation Key**
Activates the blower.
- 9 Key Socket**
Accommodates the activation key.
- 10 Control Handle**
For operating, controlling and carrying the blower.
- 11 Blower tube**
Directs the airstream.
- 12 Nozzle**
Directs and concentrates the airstream.

13 Charger Plug

Connects charging cable to charger socket.

14 Connecting Cable

Connects charger plug to appliance plug.

15 Appliance Plug

Connects charging cable to wall outlet.

16 Charging Cable

Serves to charge the blower.

Rating label with serial number

3.2 Symbols

Meanings of symbols that may be on the blower and charging cable:

 This symbol indicates in what direction the release slide has to be pushed.

 Guaranteed sound power level according to directive 2000/14/EC in dB(A) in order to make sound emissions of products comparable.

 This symbol shows that an LK 45 charging cable must be used.

 The data next to this symbol indicates the energy content of the battery according to the cell manufacturer's specification. The energy content available during operation is lower.

 Operate the electric appliance in a dry place, indoors only.

 Do not dispose of the product with your household waste.

 Mount so that the arrows point vertically upwards.

4 Safety Precautions

4.1 Introduction

This product was designed for safe operation and features safety devices. Nevertheless, you should observe the following safety precautions in order to avoid possible dangers.

4.2 Warning Symbols

Meanings of warning signs and labels on the blower or charging cable:

 Observe safety notices and take the necessary precautions.

 Read, understand and keep the User Manual.



Wear safety glasses.



Securely tie back long hair so that it cannot be pulled into the blower.



Always remove the activation key during breaks in work, transport, charging, storage, maintenance and repairs.



Protect the blower from rain and damp – do not immerse it in fluids.



Maintain a safe distance.



Protect the blower from heat and fire.



Observe the blower's specified temperature range.

4.3 Intended Use

The STIHL BGA 45 blower is designed for blow-sweeping leaves, grass, paper and similar matter.

Do not use the blower in the rain.

A built-in battery supplies the blower with power.

The STIHL LK 45 charging cable recharges the STIHL BGA 45 blower.

▲ WARNING

- Charging cables or power supply units not explicitly approved for the blower by STIHL may cause a fire or explosion. This can result in serious or fatal injuries and damage to property.
 - ▶ Always recharge a STIHL BGA 45 blower with a STIHL LK 45 charging cable.
- Using the blower or the charging cable for purposes for which they were not designed may result in serious or fatal injuries and damage to property.
 - ▶ Use the blower and charging cable as described in this instruction manual.

4.4 The Operator

▲ WARNING

- Users without adequate training or instruction cannot recognize or assess the risks involved in using the blower and charging cable. The user or other persons may sustain serious or fatal injuries.



- ▶ Read, understand and save the instruction manual.

- ▶ If you pass the blower and charging cable on to another user: Always give them the instruction manual.

- ▶ Make sure the user meets the following requirements:
 - The user must be rested.

– The user must be in good physical condition and mental health to operate and work with the blower and the charging cable. If the user's physical, sensory or mental ability is restricted, he or she may work only under the supervision of or as instructed by a responsible person.

- The user is able to recognize and assess the risks involved in using the blower and charging cable.

– The user must be of legal age or is being trained in a trade under supervision in accordance with national rules and regulations.

– The user has received instruction from a STIHL servicing dealer or other experienced user before working with the blower

and using the charging cable for the first time.

- The user must not be under the influence of alcohol, medication or drugs.
- ▶ If you have any queries: Contact a STIHL servicing dealer for assistance.

4.5 Clothing and Equipment

▲ WARNING

- Long hair can be sucked into the blower during operation. This can result in serious injuries.



- ▶ Tie up long hair so that it is above shoulder level.

- Objects can be thrown through the air at high speed during operation. This can result in personal injury.



- ▶ Wear close-fitting safety glasses. Suitable glasses that have been tested and labeled in accordance with EN 166 or national standards are available from retailers.

- ▶ Wear long trousers.
- Dust can be whipped up during operation: Whipped up dust can damage the respiratory passages and cause allergic reactions.
 - ▶ If dust is generated: Wear a dust respirator mask.
- Unsuitable clothing can snag on wood, brush or the blower. Not wearing suitable clothing may result in serious injury.
 - ▶ Wear snug-fitting clothing.
 - ▶ Do not wear a scarf or jewelry.
- Wearing unsuitable footwear may cause you to slip or stumble. This can result in personal injury.
 - ▶ Wear sturdy enclosed footwear with non-slip soles.

4.6 Work Area and Surroundings

4.6.1 Blower

▲ WARNING

- Bystanders, children and animals are not aware of the dangers of the blower and objects being thrown into the air and cannot assess them. This may result in serious injury to bystanders, children and animals and damage to property.



- ▶ Do not allow bystanders, children or animals within 5 meters of the work area.

- ▶ Maintain a clearance of 5 meters from objects.
- ▶ Do not leave the blower unattended.
- ▶ Ensure that children cannot play with the blower.
- The blower is not waterproof. If you work in the rain or in a damp environment, an electric shock may occur. This can result in injuries to the user and may damage the blower.



- ▶ Do not work in the rain or in a damp environment.

- Electrical components of the blower can produce sparks. Sparks may cause fires and explosions in highly flammable or explosive environments. Persons may be seriously or fatally injured and property may be damaged.
 - ▶ Do not work in a highly flammable or explosive environment.

4.6.2 Charging cable

▲ WARNING

- Uninvolved bystanders, children and animals may not be aware of and able to understand the dangers of a charging cable or electric current. Bystanders, children and animals may be seriously or fatally injured.
 - ▶ Keep bystanders, children and animals away from the work area.
 - ▶ Do not leave the charging cable unattended.
 - ▶ Make sure that children cannot play with the charging cable.
- The charging cable is not protected against all ambient conditions. If the charging cable is exposed to certain ambient conditions, it may catch fire or explode. This could result in serious injury to people and damage to property.
 - ▶ Protect the charging cable from rain and moisture.
 - ▶ Operate the charging cable in a dry place, indoors only.

- ▶ Do not operate the charging cable in an easily combustible or explosive environment.
- ▶ Use and store the charging cable at a temperature between 0°C and 40 °C.

4.7 Safe Condition

4.7.1 Blower

The blower is in a safe condition if the following conditions are fulfilled:

- The blower is undamaged.
- Blower must be clean and dry.
- The controls function properly and have not been modified.
- Original STIHL accessories are fitted.
- The accessories are correctly attached.

▲ WARNING

- If not in safe condition, components may no longer operate correctly and safety devices may be disabled. This may result in serious or fatal injury to people.
 - ▶ Never use a damaged blower.
 - ▶ Do not charge a damaged blower.
 - ▶ If the blower is dirty or wet: Clean the blower and allow it to dry.
 - ▶ Do not modify the blower. Exception: Mounting a blower tube and nozzle approved for this blower model.
 - ▶ If the controls do not function properly: Do not work with the blower.
 - ▶ Fit original STIHL accessories designed for this blower model.
 - ▶ Attach accessories as described in this User Manual or in the User Manual for the accessories.
 - ▶ Do not insert objects into the openings of the blower.
 - ▶ Never connect or short-circuit the keyslot contacts with metallic objects.
 - ▶ Do not open the blower.
 - ▶ Replace worn or damaged labels.
 - ▶ If you have any doubts, be sure to consult a STIHL dealer.

4.7.2 Charging Cable

The charging cable is in a safe condition if the following points are observed:

- Charging cable is undamaged.
- Charging cable is clean and dry.

▲ WARNING

- If the product does not comply with safety requirements, components will no longer function properly or safety devices may be ren-

dered inoperative. This can result in serious or fatal injuries.

- ▶ Do not use a damaged charging cable.
- ▶ If the charging cable is dirty or wet: Clean the charging cable and allow it to dry.
- ▶ Do not modify the charging cable.
- ▶ **Never bridge the charging cable's contacts with metallic objects (short circuit).**
- ▶ Do not open the charging cable.

4.8 Built-in battery

▲ WARNING

- The built-in battery is not protected against all ambient conditions. If the built-in battery is exposed to certain ambient conditions, the blower may catch fire, explode or be irreparably damaged. Persons may be seriously or fatally injured, and property may be damaged.



- ▶ Protect the blower from heat and fire.
- ▶ Do not throw the blower into a fire.



- ▶ Use and store the blower at a temperature between 0°C and 50°C.

- ▶ Keep blower away from small metal parts.
- ▶ Protect the blower from rain and moisture – do not immerse it in fluids.
- ▶ Do not expose blower to high pressure.
- ▶ Do not expose blower to microwaves.
- ▶ Protect the blower from chemicals and salts.
- ▶ Do not transport a damaged blower.
- Fluid may leak from a damaged battery. If that liquid comes into contact with the skin or eyes, the skin or eyes may be irritated.
 - ▶ Avoid contact with the liquid.
 - ▶ If skin contact occurs: Wash affected areas of skin with plenty of water and soap.
 - ▶ In the event of contact with eyes: Rinse eyes with plenty of water for at least 15 minutes and consult a doctor.
- A damaged or defective battery may smell unusual, emit smoke or burn. Persons may be seriously or fatally injured, and property may be damaged.
 - ▶ If the blower smells unusual or emits smoke: Do not use the blower and keep it away from combustible substances.
 - ▶ If the blower catches fire: Extinguish the blower with a fire extinguisher or water.

4.9 Working

⚠ WARNING

- In certain situations, the user may no longer be able to concentrate on their work. This may result in the user stumbling, falling and suffering serious injury.
 - ▶ Keep calm and plan your work.
 - ▶ If light and visibility are poor: Do not work with the blower.
 - ▶ Do not use the blower on your own.
 - ▶ Do not work above shoulder height.
 - ▶ Watch out for obstacles.
 - ▶ Work standing on the ground and keep your balance. If you have to work at a height: Use a mobile elevating work platform or secure scaffolding.
 - ▶ If you start feeling fatigue: Take a break. If you start feeling fatigue: Take a break.
 - ▶ Blow in direction of the wind.
- Objects can be ejected at high speed during operation. This can result in injuries to persons and animals and damage to property.
 - ▶ Do not direct air blast towards people, animals or objects.
- If the blower starts behaving differently or in an unusual way while operating, the blower may be in an unsafe condition. This could result in serious injury to people and damage to property.
 - ▶ Stop work, remove the activation key and contact your STIHL servicing dealer.
- Vibrations may occur during blower operation.
 - ▶ Take breaks.
 - ▶ If signs of a circulatory disturbance occur: Consult a doctor.
- The dust whipped up may cause the blower to be electrostatically charged. In certain conditions (e.g. dry environment) the blower may discharge suddenly and emit sparks. Sparks may cause fires and explosions in highly flammable or explosive environments. Persons may be seriously or fatally injured and property may be damaged.
 - ▶ Do not work in a highly flammable or explosive environment.

4.10 Charging

Contact with live components may occur for the following reasons:

- The connecting cable is damaged.
- The mains plug is damaged.
- The socket is not properly installed.

⚠ DANGER

- Contact with live parts may result in electric shock. This may result in serious or fatal injury to the user.
 - ▶ Make sure that the connecting cable and mains plug are undamaged.
 - ▶ Plug the mains plug into a correctly installed socket.
- Overvoltage can occur in the charging cable if an incorrect grid voltage or frequency is used during charging. The charging cable may be damaged.
 - ▶ Make sure the grid voltage and frequency match the data on the charging cable's rating label.
- If the charging cable is connected to a power strip, electrical components may be overloaded during the charging process. The electric components may overheat and cause a fire. Persons may be seriously or fatally injured, and property may be damaged.
 - ▶ Ensure that the technical specifications for the power strip are not exceeded by the information on the rating plate of the charging cable and of all electrical devices connected to the power strip.
- A damaged or defective charging cable may produce an unusual smell or emit smoke during the charging process. Persons may be injured, or property may be damaged.
 - ▶ Disconnect the mains plug from the power supply.
- The charging cable can overheat and cause a fire if heat dissipation is inadequate. Persons may be seriously or fatally injured, and property may be damaged.
 - ▶ Do not cover the charging cable.

4.11 Transporting

⚠ WARNING

- The blower can turn over or move while being transported. This may result in personal injuries and damage to property.



- ▶ Remove the activation key.
- ▶ Pack the blower in packaging or a transport box in such a way that it cannot move.
- ▶ Secure the packaging or transport box with lashing straps or a net so that the packaging or transport box cannot move.

4.12 Storing

4.12.1 Blower

⚠ WARNING

- Children are not aware of and cannot assess the dangers of a blower and can be seriously injured.



- ▶ Remove the activation key.

- ▶ Store the blower out of the reach of children.

- Dampness can corrode the electrical contacts in the activation key socket and metal components. The blower may be damaged.



- ▶ Remove the activation key.

- ▶ Store the blower in a clean and dry condition.

- The blower is not protected against all ambient conditions. The blower may be damaged if it is exposed to certain ambient conditions.

- ▶ Store the blower in a clean and dry condition.
- ▶ Store the blower in a closed location.
- ▶ Store the activation key separately from the blower.

4.12.2 Charging Cable

⚠ WARNING

- Children are not aware of and cannot assess the dangers of a charging cable. Children may sustain serious or fatal injuries.

- ▶ Keep the charging cable out of the reach of children.

- The charging cable is not protected against all ambient conditions. The charging cable may be damaged if it is exposed to certain ambient conditions.

- ▶ If the charging cable is hot: Allow the charging cable to cool down.

- ▶ Store the charging cable in a clean and dry condition.

- ▶ Store the charging cable in a confined space.

- ▶ Store the charging cable within temperature range of 0°C to +40°C.

4.13 Cleaning, Maintenance and Repair

⚠ WARNING

- The blower may start unintentionally if the activation key remains inserted during cleaning, maintenance or repair operations. This could result in serious injury to people and damage to property.



- ▶ Remove activation key.

- Harsh detergents, cleaning with a water jet or sharp objects can damage the blower and charging cable. If the blower or charging cable are not cleaned correctly, components may no longer function properly or safety devices may be rendered inoperative. They may cause serious injury to persons.

- ▶ Clean the blower and charging cable as described in this instruction manual.

- If the blower or charging cable are not serviced or repaired correctly, components may no longer function properly or safety devices may be rendered inoperative. This may result in serious or fatal injury to people.

- ▶ Do not attempt to service or repair the blower or charging cable.

- ▶ If the blower or the charging cable require servicing or repairs: Contact your STIHL servicing dealer for assistance.

5 Preparing the Blower for Operation

5.1 Preparing the Blower for Operation

The following steps must be performed before commencing work:

- ▶ Ensure that the following components are in safe condition:
 - Blower, 4.7.1.
 - Charging cable, 4.7.2.
- ▶ Check the built-in battery, 10.2.
- ▶ Fully charge the blower, 6.
- ▶ Clean blower, 15.1.
- ▶ Mount the blower tube and nozzle, 7.
- ▶ Check the controls, 10.
- ▶ If it is not possible to carry out these steps, do not use the blower. Consult a STIHL servicing dealer.

6 Charging the Blower, LEDs

6.1 Charging the Blower

The charging time depends on several factors, e.g. temperature of the blower or ambient temperature. The actual charging time may differ from the specified charging time. For specified charging times see www.stihl.com/charging-times.

The charging process starts automatically when the plug is inserted in a wall outlet and the charging cable is connected to the blower. The charging process stops automatically when the blower is fully charged.

The blower and charging cable heat up during the charging process.

- ▶ Remove the activation key.

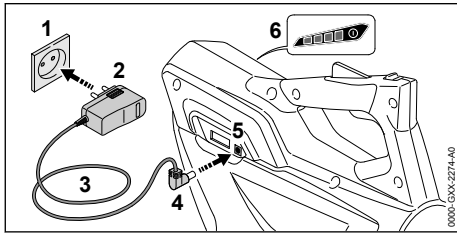

- ▶ Insert the plug (2) in a convenient wall outlet (1).

! WARNING

- Persons may trip over the connecting cable. This can result in injuries and may damage the charging cable.
 - ▶ Lay the connecting cable flat on the floor.
- ▶ Position the connecting cable (3).
- ▶ Insert the charger plug (4) in the charge socket (5). The LEDs (6) glow green and show the state of charge.
- ▶ If the LEDs (6) stop glowing: Disconnect the charger plug (4) from the charge socket (5). The blower is fully charged.
- ▶ Disconnect the plug (2) from the wall outlet (1).

6.2 State of Charge

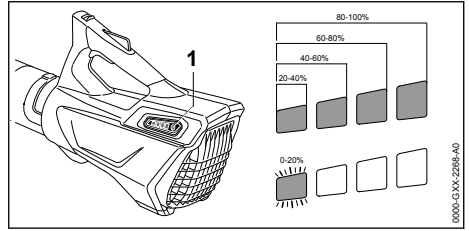

- ▶ Press the button (1). The LEDs (5) glow green for about 5 seconds and indicate the state of charge.
- ▶ If the LED on the right flashes green: Recharge the blower.

6.3 LEDs

The LEDs can indicate the state of charge or malfunctions in the blower. The LEDs can glow or flash green or red.

The state of charge is indicated when the LEDs glow or flash green.

- ▶ If the LEDs glow or flash red: Troubleshooting, 17. Malfunction in blower.

7 Assembling the Blower

7.1 Mounting the Blower Tube and Nozzle

- ▶ Switch off the blower and remove the activation key.

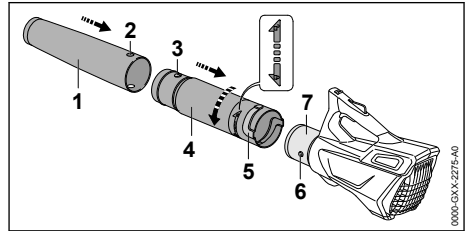

- ▶ Line up the hole (2) and the lug (3).
- ▶ Push the nozzle (1) onto the blower tube (4). The nozzle (1) engages audibly and can no longer be removed.
- ▶ Line up the lug (6) and the slot (5).
- ▶ Push the blower tube (4) onto the housing (7).
- ▶ Rotate nozzle (4) in direction of \odot until it engages.

There is no need to remove the blower tube again.

8 Inserting and Removing Activation Key

8.1 Inserting the Activation Key

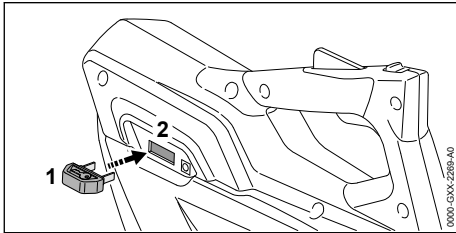

- ▶ Insert the activation key (1) in the socket (2).

8.2 Removing the Activation Key

- ▶ Stand the blower on a level surface.
- ▶ Remove the activation key.
- ▶ Keep the activation key out of the reach of children.

9 Switching the Blower On/Off

9.1 Switching On

- ▶ Hold the blower with one hand on the control handle - wrap you thumb around the handle.

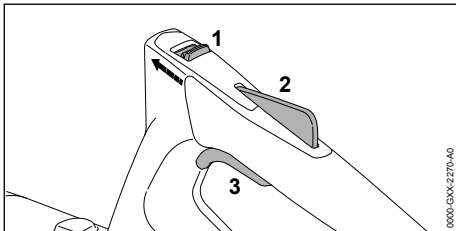

- ▶ Push the release slide (1) in the direction of the blower tube with your thumb and hold it there.
- ▶ Depress the trigger lockout (2) with your hand and hold it there.
You can let go of the release slide (1).
- ▶ Pull the trigger (3) with your index finger and hold it there.
The blower accelerates and air flows from the nozzle.

9.2 Switching Off

- ▶ Release the trigger and lockout lever at the same time.
No air flows from the nozzle.

- ▶ If air continues to flow from nozzle: Remove the activation key and contact your STIHL servicing dealer.
Blower has a malfunction.

10 Testing the Blower and Battery

10.1 Checking the Controls

Release slide, trigger lockout and trigger

- ▶ Remove the activation key.
- ▶ Attempt to pull the trigger lever without depressing the release slide and the trigger lockout.
- ▶ If the trigger can be pulled: Do not use the blower and contact your STIHL servicing dealer.
Release slide or trigger lockout is faulty.
- ▶ Push the release slide in the direction of the blower tube with your thumb and hold it there.
- ▶ Depress the trigger lockout and hold it in that position.
- ▶ Pull the trigger.
- ▶ Let go of the trigger, trigger lockout and release slide.
- ▶ If the trigger, trigger lockout or release slide is stiff or does not spring back to the idle position: Do not use the blower and contact your STIHL servicing dealer.
The trigger, trigger lockout or release slide has a malfunction.

Switching On

- ▶ Insert the activation key.
- ▶ Push the release slide in the direction of the blower tube with your thumb and hold it there.
- ▶ Depress the trigger lockout and hold it in that position.
- ▶ Pull the trigger and hold it there.
Air flows from the nozzle.
- ▶ If 3 LEDs flash red: Remove the activation key and contact your STIHL servicing dealer.
Malfunction in blower.
- ▶ Release the trigger.
No air flows from the nozzle.
- ▶ If air continues to flow from nozzle: Remove the activation key and contact your STIHL servicing dealer.
Blower has a malfunction.

10.2 Checking the Built-In Battery

- ▶ Press the button.
The LEDs glow or flash.

- ▶ If the LEDs do not glow or flash: Do not use the blower and contact your STIHL servicing dealer.
There is a malfunction in the built-in battery.

11 Operating the Blower

11.1 Holding and Controlling the Blower

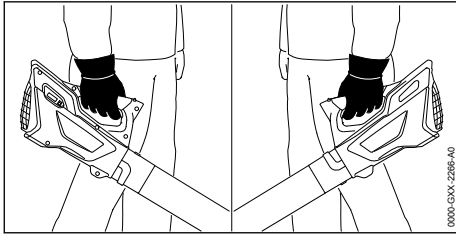

- ▶ Hold and control the blower with one hand on the control handle - wrap your thumb around the handle.

11.2 Blow-Sweeping

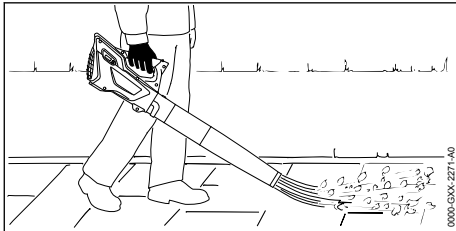

- ▶ Point the nozzle at the ground.
- ▶ Walk slowly and steadily forwards.

12 After Finishing Work

12.1 After Finishing Work

- ▶ Switch off the blower and remove the activation key.
- ▶ Clean the blower.

13 Transporting

13.1 Transporting the blower

- ▶ Switch off the blower and remove the activation key.

Carrying the blower

- ▶ Carry blower by the control handle in one hand.

Transporting the blower in a vehicle

- ▶ Secure the blower so that it cannot tip over or move.

- ▶ If the blower is to be packaged: Package the blower in such a way that it cannot move inside its packaging and secure the packaging in such a way that it cannot move.

Due to the built-in battery, the blower is subject to the requirements for transporting dangerous goods. The blower is classified as UN 3481 (lithium-ion batteries in equipment) and has been tested pursuant to UN Manual Tests and Criteria Part III, Subsection 38.3.

The transport regulations can be found at www.stihl.com/safety-data-sheets.

14 Storing

14.1 Storing the blower

STIHL recommends that you store the blower with a charge between 40% and 60% (2 LEDs lit up green).

- ▶ Switch off the blower and remove the activation key.
- ▶ The blower should be stored in such a way that the following conditions are fulfilled:
 - Blower must be out of the reach of children.
 - Blower must be clean and dry.
 - Blower is in an enclosed space.
 - Blower is separated from the charging cable.
 - Blower is in a temperature range between 0°C and 50°C.

NOTICE

- If the blower is not stored as described in this User Manual, the installed battery may become deeply discharged and irreparably damaged.
 - ▶ Charge a discharged blower prior to storing it. STIHL recommends that you store the blower with a charge between 40% and 60% (2 LEDs lit up green).

14.2 Storing the Charging Cable

- ▶ Disconnect the plug from the wall outlet.
- ▶ Observe the following points when storing the charging cable:
 - Charging cable is out of the reach of children.
 - Charging cable is clean and dry.
 - Charging cable is in an enclosed space.
 - Charging cable is separated from the blower.
 - Charging cable is in a temperature range between 0°C and +40 °C.

15 Cleaning

15.1 Cleaning the blower

- ▶ Switch off the blower and remove the activation key.
- ▶ Clean blower with a damp cloth.
- ▶ Clean vents with a paintbrush.
- ▶ Clean the shield with a paintbrush or soft brush.

15.2 Cleaning the charging cable

- ▶ Disconnect the plug from the wall outlet.
- ▶ Disconnect the charger plug from the charge socket.
- ▶ Clean the charging cable with a damp cloth.

16 Maintenance and Repairs

16.1 Maintenance Intervals

The maintenance intervals are dependent on the environmental and operating conditions. STIHL recommends the following maintenance intervals:

17 Troubleshooting

17.1 Troubleshooting Blower or Charging Cable

Condition	LEDs on blower	Cause	Remedy
Blower does not start when switched on	1 LED flashes green.	Blower has low charge.	▶ Recharge the blower.
	3 LEDs glow red.	Blower is too hot.	▶ Remove the activation key. ▶ Allow blower to cool down.
	3 LEDs flash red.	There is a electrical malfunction.	▶ Remove the activation key. ▶ Do not use the blower and contact your STIHL servicing dealer for assistance.
		Blower is damp.	▶ Allow the blower to dry.
Blower cuts out during operation	3 LEDs glow red.	Blower is too hot.	▶ Remove the activation key. ▶ Allow blower to cool down.
		There is a electrical malfunction.	▶ Switch off the blower, wait 5 seconds and then switch on again.
Blower runtime is too short		The blower is not fully charged.	▶ Fully charge the blower.
		Normal blower life has been exceeded.	▶ Replace the blower.
Blower is not being charged.	3 LEDs glow red.	Blower is too hot.	▶ Remove the activation key. ▶ Allow blower to cool down.
		Malfunction in blower or charging cable.	▶ Remove the activation key. ▶ Contact a STIHL servicing dealer for assistance.

18 Specifications

18.1 STIHL BGA 45 Blower

- Weight: 2.2 kg

Every 12 months

- ▶ Have the blower checked by a STIHL servicing dealer.

16.2 Servicing and Repairing the Blower

The blower cannot be serviced or repaired by the user.

- ▶ If your blower has a malfunction or is damaged or requires servicing: Contact your STIHL servicing dealer.

16.3 Servicing and repairing the charging cable

The charging cable requires no servicing and cannot be repaired.

- ▶ If the charging cable is defective or damaged: Replace the charging cable.

- Air speed with nozzle mounted: 38 m/s
- Battery technology: Lithium-ion
- Voltage: 18 V
- Capacity in Ah: see rating label

- Energy content in Wh: see rating label
- Permissible temperature range for operation and storage: 0°C up to 50°C

If the blower is used at temperatures higher than 30°C, the battery runtime may be shortened and the blower's performance reduced.

Consult www.stihl.com/battery-life for the respective running time.

18.2 STIHL LK 45 Charging Cable

- Voltage: 100-240 V, 50–60 Hz
- Power rating: 14.6 W
- Charge current: 0.65 A
- Permissible temperature range for operation and storage: 0°C up to 40 °C

For charging times see www.stihl.com/charging-times.

18.3 Noise and Vibration Data

K-value for sound pressure level is 2 dB(A). K-value for sound power level is 2 dB(A). K-value for vibration level is 2 m/s².

STIHL recommends that you wear hearing protection.

- Sound pressure level L_{pA} measured according to EN 50636-2-100: 76 dB(A)
- Sound power level L_{WA} measured according to EN 50636-2-100: 87 dB(A)
- Vibration measurement a_{hv} measured according to EN 506362100; control handle: 3.2 m/s²

The vibration values quoted above have been measured according to a standardized test procedure and may be used to compare electric power tools. Depending on the type of usage, the vibrations that actually occur may differ from the values quoted. The vibration values quoted may be used for an initial assessment of the user's exposure to vibrations. The actual exposure to vibrations has to be estimated. This process may also take into account times during which the electric power tool is switched off and times during which it is switched on but running off load.

Information on compliance with Vibration Directive 2002/44/EC is available at www.stihl.com/vib.

18.4 REACH

REACH is an EC regulation and stands for the Registration, Evaluation, Authorisation and Restriction of Chemical substances.

For information on compliance with the REACH regulation see www.stihl.com/reach.

19 Spare Parts and Accessories

19.1 Spare parts and accessories

STIHL  These symbols indicate original STIHL spare parts and original STIHL accessories.

STIHL recommends the use of original STIHL spare parts and accessories.

Despite ongoing market observation, STIHL is unable to judge the reliability, safety and suitability of other manufacturers' spare parts and accessories; accordingly, STIHL cannot warrant for the use of those parts.

Original STIHL spare parts and original STIHL accessories are available from STIHL dealers.

20 Disposal

20.1 Disposing of Blower and Charging Cable

Contact the local authorities or your STIHL dealer for information on disposal.

Improper disposal can be harmful to health and pollute the environment.

The blower contains a built-in rechargeable battery which must be disposed of separately.

- ▶ Return the blower to a STIHL servicing dealer for disposal.
The STIHL dealer removes the built-in battery from the blower for separate disposal.
- ▶ Take STIHL products including packaging to a suitable collection point for recycling in accordance with local regulations.
- ▶ Do not dispose with domestic waste.

21 EC Declaration of Conformity

21.1 STIHL BGA 45 Blower

ANDREAS STIHL AG & Co. KG
Badstraße 115
D-71336 Waiblingen

Germany

declare under our sole responsibility that

- Type: Cordless blower
- Manufacturer's brand: STIHL
- Model: BGA 45

– Serial number: 4513

conforms to the specifications of Directives 2011/65/EU, 2006/42/EC, 2014/30/EU and 2000/14/EC and has been developed and built in compliance with the versions of the following standards valid at the production date: EN 55014-1, EN 55014-2, EN 60335-1 and EN 50636-2-100.

The measured and guaranteed equivalent sound power level has been determined in accordance with Directive 2000/14/EC, Annex V.

- Measured sound power level: 86 dB(A)
- Guaranteed sound power level: 89 dB(A)

The technical documents are stored at ANDREAS STIHL AG & Co. KG Produktzulassung.

The year of construction, the country of manufacture and the machine number are shown on the blower.

Done at Waiblingen, 15.07.2021

ANDREAS STIHL AG & Co. KG

J. Hoffmann

pp

Dr. Jürgen Hoffmann, Director Product Certification & Regulatory Affairs

Compatibility Regulations 2016 and Noise Emission in the Environment by Equipment for use Outdoors Regulations 2001 and has been manufactured in compliance with the following standards in the versions valid on the date of production: EN 55014-1, EN 55014-2, EN 60335-1 and EN 50636-2-100.

The measured and the guaranteed sound power level have been determined in accordance with UK regulation Noise Emission in the Environment by Equipment for use Outdoors Regulations 2001, Schedule 8..

- Measured sound power level: 86 dB(A)
- Guaranteed sound power level: 89 dB(A)

The technical documents are stored at ANDREAS STIHL AG & Co. KG Produktzulassung.

The year of construction, the country of manufacture and the machine number are shown on the blower.

Done at Waiblingen, 15.07.2021

ANDREAS STIHL AG & Co. KG

J. Hoffmann

pp

Dr. Jürgen Hoffmann, Director Product Certification & Regulatory Affairs

22 UKCA Declaration of Conformity

22.1 STIHL BGA 45 Blower

**UK
CA**

ANDREAS STIHL AG & Co. KG
Badstraße 115
D-71336 Waiblingen
Germany

declare under our sole responsibility that

- Type: Cordless blower
- Manufacturer's brand: STIHL
- Model: BGA 45
- Serial number: 4513

conforms to the relevant provisions of UK regulations The Restriction of the Use of Certain Hazardous Substances in Electrical and Electronic Equipment Regulations 2012, Supply of Machinery (Safety) Regulations 2008, Electromagnetic

www.stihl.com



0458-719-0121-C



0458-719-0121-C