

Clarke®



PROFESSIONAL DIGITAL CLAMPMETER - 6 FUNCTION

MODEL No: CDM90

Part No: 450097

OPERATING & MAINTENANCE INSTRUCTIONS



GC0111

INTRODUCTION

Thank you for purchasing this CLARKE CDM90 Digital Clampmeter.

Please read this manual thoroughly and follow the instructions carefully, in doing so you will ensure that operations are carried out in complete safety and you can look forward to the product giving you long and satisfactory service.

GUARANTEE

This CLARKE product is guaranteed against faulty manufacture for a period of 12 months from the date of purchase. Please keep your receipt as proof of purchase. This guarantee is invalid if the product is found to have been abused or tampered with in any way, or not used for its intended purpose.

Faulty goods should be returned to their place of purchase, no product can be returned to us without prior permission.

This guarantee does not effect your statutory rights.

Specification

CDM90 SPECIFICATIONS	
Max voltage between terminals & earth	CATIII 1000V and CAT III 600V DC
Max operating altitude	2000 metres (7000 feet)
Display	LCD, updates 2-3 sec
Maximum value display	1999
Operating Power	1 x 9V battery, (PP3)
Temperature Coefficient (<18 to >28°C)	< 0.1 x specified accuracy/°C
Operating Temp	0°C to 40°C (32°F to 104°F)
Storage Temp	-10°C to 50°C (10°F to 122°F)
Dimensions (L x W x H)	250 x 99 x 43 mm
Weight (exc leads)	460 g inc battery
Jaw Opening	42 mm (max conductor size)

CONTENTS

SAFETY INFORMATION	4
Preliminary	4
During Use	4
Symbols	5
DESCRIPTION	6
Components of the Meter	7
The LCD (Liquid Crystal Display)	8
OPERATION INSTRUCTIONS	9
Holding Readings	9
Backlight	9
Measuring AC Current	10
Measuring AC Voltage	10
Measuring DC Voltage	11
Measuring Resistance	12
Testing Diodes	12
Continuity Testing	13
MAINTENANCE	14
General Care	14
Replacing the Battery	14
Replacing Test Leads	14
Calibration	14
DECLARATION OF CONFORMITY	15

SAFETY INFORMATION



WARNING

Take care when using this meter. Improper use can result in electric shock or damage to the meter. Take all normal safety precautions and follow the safeguards suggested in this manual.

PRELIMINARY

1. When using the meter, the user must observe all normal safety rules concerning:
 - General protection against electric shock
 - Protection of the meter against misuse.
2. When the meter is delivered, confirm it has not been damaged in transit.
3. Before using, check that the insulation on the test leads has not been damaged or any wire exposed.
4. Use only the test leads supplied to ensure operational safety. If necessary, they must be replaced with test leads of the same model or class.

DURING USE

1. Do not take measurements that exceed the maximum values for this meter.
2. Do not touch the metal probes of the test leads when the meter is connected to the circuit being measured.
3. Keep your fingers behind the probe barriers when taking measurements.
4. Do not take voltage measurements if you suspect the value exceeds 1000V.
5. If the appropriate value range is unknown select the highest range on the scale.
6. Disconnect the test leads from the circuit under test before turning the rotary function selector.
7. Do not measure the resistance, diode or continuity of live circuits.
8. Never touch exposed wiring, connections or any live circuit while taking any measurements.
9. Do not use the meter near explosive gases or steam.

10. Stop using the meter if any abnormalities or faults are observed.
11. Do not use the meter unless its rear case and battery cover are correctly and securely fastened.
12. Do not store or use the meter in areas exposed to direct sunlight, at high temperature or with high relative humidity.
13. To avoid false readings, replace the battery as soon as the Low Battery indicator appears.
14. Before use, verify the meter operation by measuring a known voltage.
15. Keep your body isolated from ground by using dry clothing, rubber shoes, rubber mats or any approved insulating material.

SYMBOLS



Caution, risk of danger.



Beware electrical hazards.



Double insulation (Protection class II).



Conforms to the European Union Directive



Earth (ground) terminal

DESCRIPTION

This meter is a portable, professional, measuring instrument with a Liquid Crystal Display (LCD) and back light for easily reading.

The meter can perform measurements of AC current, AC/DC voltage, as well as resistance, continuity and diode testing.

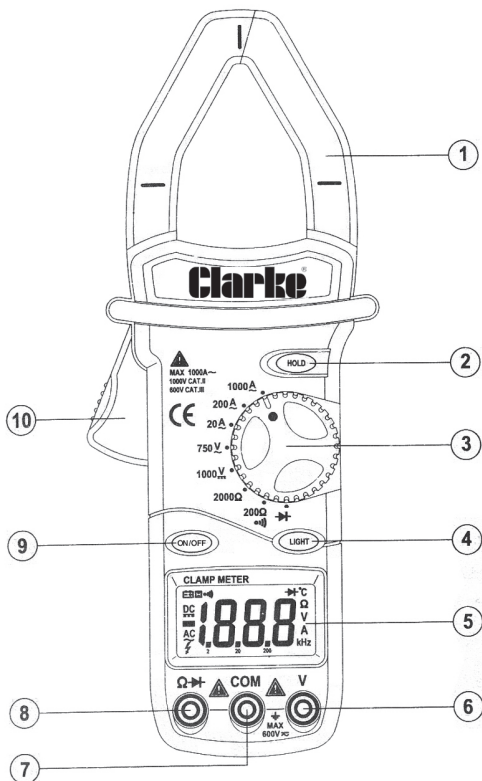

COMPONENTS OF THE METER

1. Moving Jaw Measures AC current flowing through the conductor
2. **HOLD** Button When this button is pressed, the display will keep the last reading and "H" symbol will appear on the LCD until the button is pressed again.
3. Rotary Selector Used to select functions and ranges.
4. Light Button Press this and the backlight display will come on. After approx 4-6 seconds the light will automatically turn off.
5. (LCD) Liquid Crystal Display.
6. 'V' Jack This is the positive input terminal for measuring Voltage. Connection is made using the red lead.
7. **COM** Jack This is the negative (ground) input terminal for all measurement modes except current. Connection is made to it using the black lead.
8. Ω \rightarrow \vdash Jack This is the positive input terminal for ohms and diode measurement. Connection is made using the red lead.
9. On/Off Button Used to turn the meter on/off.
10. Trigger Used to open the jaws.

THE LCD (Liquid Crystal Display)

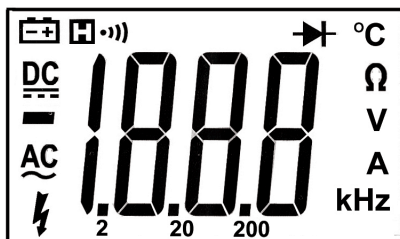

Alternating current



Direct current



Diode test



Continuity buzzer



Battery low



This indicates that the display data is being held.



Voltage



Amperes (Current)



Ohms, Kilo-ohms, Mega-ohms (Resistance)



Outside recommended working temperature range



Voltage or current should not exceed the specified value



Kilohertz (Frequency)



OPERATION INSTRUCTIONS

1. Switch on the power by pressing the ON/OFF button.
2. Turn the rotary selector to the required function and range to be measured. Choose the highest range when the value of the voltage or current to be measured is unknown.
3. Connect the black earth test lead before the red positive test lead when making the connection. Remove the positive test lead first when disconnecting.

HOLDING READINGS

1. Press the **HOLD** button while taking measurements.
 - The value on the display will be held.
2. Press the **HOLD** button again to release the function.

THE BACK LIGHT

1. Press the **LIGHT** button to switch on the back light if the natural light in the environment is too dim for taking readings.
 - The backlight will turn off automatically after 6 seconds.

NOTE:

- Frequent use of the back light will shorten the life of the battery and therefore should not be used unnecessarily.

Low Battery Indicator

When the battery voltage falls too low, the Low Battery symbol,  will appear on the LCD. The accuracy of measurement cannot be assured when the symbol appears.

NOTE:

- When the back light is on, the low battery symbol may appear due to the greater working current causing the voltage to drop. In this case, there is no need to replace the battery until the Low Battery symbol appears when the back light is not being used.

MEASURING AC CURRENT

Ensure the test leads are disconnected from the meter before making current clamp measurements.

1. Set the rotary selector to the **A** range position.
2. Squeeze the trigger to open the jaw. Fully enclose only one conductor.
3. Take the reading showing on the LCD.

NOTE:

- If the figure "1" is displayed, this indicates the current has exceeded the maximum value allowed in the range, and a higher range should be selected.
- For accurate results, only enclose one conductor in the jaws.
- For optimum results, centre the conductor in the jaws.

Range	Resolution	Accuracy
20A	0.01A	$\pm 2.0\%$ of rdg ± 5 digits
200A	0.1A	$\pm 2.0\%$ of rdg ± 5 digits
1000A	1A	$\pm 2.0\%$ of rdg ± 7 digits

- Overload protection: 1200A for 60 seconds maximum
- Frequency range: 50 to 60Hz

MEASURING AC VOLTAGE

Pay special attention to avoid electric shock if measuring high voltages.

Do not connect to a voltage of more than 750V rms AC.

1. Plug the black test lead into the **COM** jack and red test lead into the **V~** jack.
2. Set the rotary selector to the 750V~ position.
3. Connect the test leads to the voltage source being measured.
4. Note the reading on the LCD.

Range	Resolution	Accuracy
750V	1V	$\pm 1.0\%$ of rdg ± 5 digits

- Input impedance 10M Ω
- Frequency range: 40 to 400Hz
- Response average, calibrated in rms of sine wave

NOTE:

- At the low voltage range, unsteady readings may appear before the test leads touch the circuit due to the sensitivity of the meter. When the test leads touch the circuit, the true reading will be shown.

MEASURING DC VOLTAGE

Pay special attention to avoid electric shock if measuring high voltages.

Do not connect to a voltage greater than 1000V DC.

1. Plug the black test lead into the **COM** jack & the red lead into the **V** jack.
2. Set the rotary selector to the **1000V**  position.
3. Connect the leads to the voltage source or load terminals for measurement.
4. Take the reading on the LCD noting the polarity of the red/black lead connections.

Range	Resolution	Accuracy
1000V	1V	$\pm 1.0\%$ of rdg ± 2 digits

- Input impedance 10M Ω

NOTE:

- At the lower voltage range, unsteady readings will appear before the test leads touch the circuit due to the sensitivity of the meter. When the test leads touch the circuit, the true reading will be shown.

MEASURING RESISTANCE

When measuring in-circuit resistance, make sure that the circuit under test has been turned off and that all capacitors have been fully discharged.



1. Connect the red test lead into the Ω  jack & the black lead into the **COM** jack.
2. Set the rotary selector to the *W* range position.
3. Connect the leads to the ends of the resistor or circuit for measurement.
4. Note the reading on the LCD.

Range	Resolution	Accuracy
200 ohm	0.1 ohm	$\pm 1.0\%$ of rdg ± 3 digits
2000 ohm	1.0 ohm	$\pm 1.0\%$ of rdg ± 3 digits



NOTE:

- If the figure "1" is displayed, this indicates the resistance has exceeded the maximum value allowed in the range, and a higher range should be selected.

TESTING DIODES

1. Connect the red test lead into the Ω  jack & the black lead into the **COM** jack.
2. Set the rotary selector to the  position.
3. Connect the red test lead to the anode and the black test lead to the cathode of the diode for testing.
4. Take the reading on the LCD. The approx. forward voltage drop of the diode will be displayed. If the connection is reversed, only figure "1" will be shown.

CONTINUITY TESTING

1. Plug the black test lead into the **COM** jack & the red lead into the Ω  jack.
2. Set the range switch to the  position.
3. Connect the test leads to the two ends of the circuit for measurement.
4. If continuity exists, the built-in buzzer will sound.

MAINTENANCE

GENERAL CARE

1. Switch off the power when the meter is not in use.
2. If the meter will remain unused for a long time, remove the battery and store it in the carry case to avoid possible damage.
3. Do not attempt to remove the rear case to adjust or repair the meter. Such actions should only be performed by a technician who fully understands the meter and the dangers involved.
4. Use a damp cloth and mild detergent to clean the meter. Do not use abrasives or solvents.

BATTERY REPLACEMENT

The battery required is a single 9V type PP3.

If the  sign appears, it indicates that the battery should be replaced.

1. Disconnect the test leads from live equipment before opening the battery cover. Loosen the fixing screw on the battery cover and remove it.
2. Replace the exhausted battery with a new one. Take care that the polarity of the battery is correct, as marked on the inside of the housing.
3. Replace the battery cover and secure with the fixing screw.
4. Dispose of your old battery in accordance with local regulations.

REPLACING THE TEST LEADS

A test lead must be replaced if the insulation layer has been damaged. The replacement leads must be in good condition with the same rating as the originals i.e. 1000V.

CALIBRATION

Calibration should be carried out once a year. This task should be assigned to a qualified service technician. Accuracy is specified for period of one year after calibration and at 18°C to 28°C (64°F to 82°F).

DECLARATION OF CONFORMITY



Clarke[®]
INTERNATIONAL

Hemnall Street, Epping, Essex CM16 4LG

DECLARATION OF CONFORMITY

This is an important document and should be retained.

We hereby declare that this product(s) complies with the following directive(s):

2004/108/EC *Electromagnetic Compatibility Directive.*

2006/95/EC *Low Voltage Equipment Directive.*

The following standards have been applied to the product(s):

EN 61326:1997+A1+A2+A3, EN 61010-1:2001, EN 61010-2-032:2002.

The technical documentation required to demonstrate that the product(s) meet(s) the requirement(s) of the aforementioned directive(s) has been compiled and is available for inspection by the relevant enforcement authorities.

The CE mark was first applied in: 2007

Product Description: Digital Clamp Multimeters
Model number(s): CDM90-CDM95
Serial / batch Number: N/A
Date of Issue: 26/10/2010

Signed:

J.A. Clarke
Director

A SELECTION FROM THE VAST RANGE OF

Clarke®

QUALITY PRODUCTS

AIR COMPRESSORS

From DIY to industrial, Plus air tools, spray guns and accessories.

GENERATORS

Prime duty or emergency standby for business, home and leisure.

POWER WASHERS

Hot and cold, electric and engine driven - we have what you need

WELDERS

Mig, Arc, Tig and Spot. From DIY to auto/industrial.

METALWORKING

Drills, grinders and saws for DIY and professional use.

WOODWORKING

Saws, sanders, lathes, mortisers and dust extraction.

HYDRAULICS

Cranes, body repair kits, transmission jacks for all types of workshop use.

WATER PUMPS

Submersible, electric and engine driven for DIY, agriculture and industry.

POWER TOOLS

Angle grinders, cordless drill sets, saws and sanders.

STARTERS/CHARGERS

All sizes for car and commercial use.

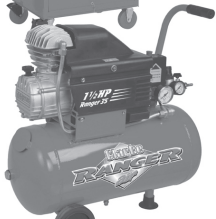

PARTS & SERVICE: 0208 988 7400

E-mail: Parts@clarkeinternational.com or Service@clarkeinternational.com

SALES: UK 01992 565333 or Export 00 44 (0)1992 565335

Clarke INTERNATIONAL Hemnall Street, Epping, Essex CM16 4LG
www.clarkeinternational.com