

DRAPER[®]

D20
MULTI-TOOL BATTERY SYSTEM



20V BRUSHLESS

HAMMER DRILL

55338 & 79894



These instructions accompanying the product are the original instructions. This document is part of the product, keep it for the life of the product passing it on to any subsequent holder of the product. Read all these instructions before assembling, operating or maintaining this product.

This manual has been compiled by Draper Tools describing the purpose for which the product has been designed, and contains all the necessary information to ensure its correct and safe use. By following all the general safety instructions contained in this manual, it will ensure both product and operator safety, together with longer life of the product itself.

All photographs and drawings in this manual are supplied by Draper Tools to help illustrate the operation of the product.

Whilst every effort has been made to ensure the accuracy of information contained in this manual, the Draper Tools policy of continuous improvement determines the right to make modifications without prior warning.

1. TITLE PAGE

1.1 INTRODUCTION:

USER MANUAL FOR: 20V Brushless Hammer Drill

Stock Nos:55338 (bare) & 79894 (with fast battery charger & battery)

Part Nos:D20CD60 & D20CD60SET

1.2 REVISIONS:

Date first published October 2018.

As our user manuals are continually updated, users should make sure that they use the very latest version.

Downloads are available from: <http://drapertools.com/manuals>

Draper Tools Limited

Hursley Road

Chandler's Ford

Eastleigh

Hampshire

SO53 1YF

UK

Website: drapertools.com

Product Helpline: +44 (0) 23 8049 4344

General Fax: +44 (0) 23 8026 0784

1.3 UNDERSTANDING THIS MANUALS SAFETY CONTENT:

WARNING! – Information that draws attention to the risk of injury or death.

CAUTION! – Information that draws attention to the risk of damage to the product or surroundings.

1.4 COPYRIGHT © NOTICE:

Copyright © Draper Tools Limited.

Permission is granted to reproduce this publication for personal and educational use only. Commercial copying, redistribution, hiring or lending is prohibited.

No part of this publication may be stored in a retrieval system or transmitted in any other form or means without written permission from Draper Tools Limited.

In all cases this copyright notice must remain intact.

2. CONTENTS

1	TITLE PAGE	
1.1	INTRODUCTION	2
1.2	REVISION HISTORY	2
1.3	UNDERSTANDING THIS MANUAL	2
1.4	COPYRIGHT NOTICE	2
2	CONTENTS	
2.1	CONTENTS.....	3
3	GUARANTEE	
3.1	GUARANTEE	4
4.	INTRODUCTION	
4.1	SCOPE	5
4.2	SPECIFICATION	5
4.3	HANDLING & STORAGE	6
5.	HEALTH AND SAFETY INFORMATION	
5.1	GENERAL SAFETY INSTRUCTIONS FOR POWER TOOL USE	7-8
5.2	ADDITIONAL SAFETY INSTRUCTIONS FOR HAMMER DRILL	8
5.3	RESIDUAL RISK	9
5.4	SAFETY INSTRUCTIONS FOR MAINS POWERED CHARGERS & BATTERY PACKS	9-10
5.5	CONNECTION TO THE POWER SUPPLY (CHARGER)	10
6.	TECHNICAL DESCRIPTION	
6.1	IDENTIFICATION	11
7.	UNPACKING AND CHECKING	
7.1	PACKAGING	12
7.2	D20 MULTI-TOOL INTERCHANGEABLE BATTERY SYSTEM	12
7.3	WHAT'S IN THE BOX.....	12
8.	PREPARING THE DRILL	
8.1	BATTERY PACK CHARGING	13-14
8.2	BATTERY PACK PROTECTION FEATURES	14
8.3	BATTERY PACK CHARGE STATUS.....	14
8.4	BATTERY LIFE EFFICIENCY AND CHARGING ADVICE	14
9.	BASIC HAMMER DRILL OPERATIONS	
9.1	INSTALLING AND REMOVING BITS	15
9.2	ROTATIONAL DRIVE SELECTION.....	15
9.3	VARIABLE SPEED TRIGGER.....	16
9.4	TORQUE SELECTION CONTROL	16
9.5	TWO SPEED GEAR BOX	16
9.6	BELT CLIP.....	17
9.7	LED WORKLIGHT.....	17
9.8	AUXILIARY HAND GRIP.....	17
9.9	SCREWDRIVING	18
9.10	DRILLING WOOD AND PLASTIC.....	18
9.11	DRILLING METAL	18
9.12	DRILLING MASONRY.....	18
10.	OPTIONAL ACCESSORIES	
10.1	OPTIONAL ACCESSORIES.....	19
11	MAINTENANCE & TROUBLESHOOTING	
11.1	MAINTENANCE	20
11.2	TROUBLESHOOTING GUIDE	20
12.	DISPOSAL	
12.1	DISPOSAL.....	21
12.2	BATTERY PACK DISPOSAL INFORMATION.....	21
13.	EXPLANATION OF SYMBOLS	
13.1	EXPLANATION OF SYMBOLS	22
DECLARATION OF CONFORMITY		ENCLOSED

3. WARRANTY

3.1 WARRANTY

Draper tools have been carefully tested and inspected before shipment and are guaranteed to be free from defective materials and workmanship.

Should the tool develop a fault, please return the complete tool to your nearest distributor or contact:

Draper Tools Limited, Chandler's Ford, Eastleigh, Hampshire, SO53 1YF. England.

Telephone Sales Desk: (023) 8049 4333 or:

Product Helpline (023) 8049 4344.

A proof of purchase must be provided.

If upon inspection it is found that the fault occurring is due to defective materials or workmanship, repairs will be carried out free of charge. This warranty period covering labour is 12 months from the date of purchase except where tools are hired out when the warranty period is 90 days from the date of purchase. The warranty is extended to 24 months for parts only. This warranty does not apply to any consumable parts, any type of battery or normal wear and tear, nor does it cover any damage caused by misuse, careless or unsafe handling, alterations, accidents, or repairs attempted or made by any personnel other than the authorised Draper warranty repair agent.

Note: If the tool is found not to be within the terms of warranty, repairs and carriage charges will be quoted and made accordingly.

This warranty applies in lieu of any other warranty expressed or implied and variations of its terms are not authorised.

Your Draper warranty is not effective unless you can produce upon request a dated receipt or invoice to verify your proof of purchase within the warranty period.

Please note that this warranty is an additional benefit and does not affect your statutory rights.

Draper Tools Limited.

4. INTRODUCTION

4.1 SCOPE

This cordless drill is designed for use with a variety of drill bits, intended for drilling holes in wood, plastic, metal, brick etc.

This product is intended for domestic and infrequent light trade use only. Any application other than that it was intended for, is considered misuse.

4.2 SPECIFICATION

Stock no.	55338 & 79894
Part no.	D20CD60 & D20CD60SET
Drilling capacity:	
Wood	35mm
Mild steel	13mm
Masonry	10mm
Maximum torque.....	60Nm
Torque settings.....	23+1
Revolutions per minute (no load)	0-1800r/min
Impact rate	0-29,700bpm
Chuck type	Keyless
Sound pressure level (LpA)*:	74.6dB(A), K=3 db(A)
Sound power level (LWA)**:	85.6dB(A), K=3 db(A)
Uncertainty (K):	3dB(A)
Vibration level hammer drilling in metal†:.....	<2.5m/s ² , K=1.5m/s ²
Vibration level hammer drilling in concrete†:.....	10.12m/s ² , K=1.5m/s ²
Weight (machine only).....	1.4kg

†When sawing in wood.

Battery pack (55338 sold separately):

Part No.	D20B4.0AH
Type	Li-ion
Rated Voltage	20V
Rating	4.0Ah

Chargers (55338 sold separately):

Part No.	D20BCS
Rated Voltage	230V~
Rated Frequency	50Hz
Rated D.C. output voltage	21.5V
Rated D.C. output current	1.65A
Protective device rated current	8A
Construction	Class II

* Continuous A-Weighted Sound Pressure Level at the workstation in accordance to and declared according to EN60745.

** The typical A-weighted noise level determined according to EN60745.

4. INTRODUCTION

4.3 HANDLING & STORAGE

- Care must be taken when handling this product.
 - Dropping this power tool could have an effect on its accuracy and could also result in personal injury. This product is not a toy and must be respected.
- Environmental conditions can have a detrimental effect on this product if neglected.
 - Exposure to damp air can gradually corrode components.
 - If the product is unprotected from dust and debris, components will become clogged.
 - If not cleaned and maintained correctly or regularly, the machine will not perform at its best.

5. HEALTH AND SAFETY INFORMATION

5.1 GENERAL SAFETY INSTRUCTIONS FOR POWER TOOL USE

When using any type of power tool there are steps that should be taken to make sure that you, as the user, remain safe.

Common sense and a respect for the tool will help reduce the risk of injury.

Read the instruction manual fully. Do not attempt any operation until you have read and understood this manual.

Most important you must know how to safely start and stop this machine, especially in an emergency.

Keep the work area tidy and clean. Attempting to clear clutter from around the machine during use will reduce your concentration. Mess on the floor creates a trip hazard. Any liquid spill on the floor could result in you slipping.

Find a suitable location. If the machine is bench mounted, the location should provide good natural light or artificial lighting as a replacement. Avoid damp and dust locations as it will have a negative effect on the machine's performance. If the machine is portable do not expose the tool to rain. In all cases do not operate power tools near any flammable materials.

Keep bystanders away. Children, onlookers and passers by must be restricted from entering the work area for their own protection. The barrier must extend a suitable distance from the tool user.

Unplug and house all power tools that are not in use. A power tool should never be left unattended while connected to the power supply. They must be housed in a suitable location, away locked up and from children. This includes battery chargers.

Do not overload or misuse the tool. All tools are designed for a purpose and are limited to what they are capable of doing. Do not attempt to use a power tool (or adapt it in any way) for an application it is not designed for. Select a tool appropriate for the size of the job. Overloading a tool will result in tool failure and user injury. This covers the use of accessories.

Dress properly. Loose clothing, long hair and jewellery are all dangerous because they can become entangled in moving machinery. This can also result in parts of body being pulled into the machine. Clothing should be close fitted, with any long hair tied back and jewellery and neck ties removed. Footwear must be fully enclosed and have a non-slip sole.

Wear personal protective equipment (PPE). Dust, noise, vibration and swarf can all be dangerous if not suitably protected against. If the work involving the power tool creates dust or fumes wear a dust mask. Vibration to the hand, caused by operating some tools for longer periods must be protected against. Wear vibration reducing gloves and allow long breaks between uses. Protect against dust and swarf by wearing approved safety goggles or a face shield. These are some of the more common hazards and preventions, however, always find out what hazards are associated with the machine/work process and wear the most suitable protective equipment available.

Do not breathe contaminated air. If the work creates dust or fumes connect the machine (if possible) to an extraction system either locally or remotely. Working outdoors can also help if possible.

Move the machine as instructed. If the machine is hand held, do not carry it by the power supply cable. If the product is heavy, employ a second or third person to help move it safely or use a mechanical device. Always refer to the instructions for the correct method.

Do not overreach. Extending your body too far can result in a loss of balance and you falling. This could be from a height or onto a machine and will result in injury.

Maintain your tools correctly. A well maintained tool will do the job safely. Replace any damaged or missing parts immediately with original parts from the manufacturer. As applicable, keep blades sharp, moving parts clean, oiled or greased, handles clean, and emergency devices working.

5. HEALTH AND SAFETY INFORMATION

Wait for the machine to stop. Unless the machine is fitted with a safety brake, some parts may continue to move due to momentum. Wait for all parts to stop, then unplug it from the power supply before making any adjustments, carrying out maintenance operations or just finishing using the tool.

Remove and check setting tools. Some machinery requires the use of additional tools or keys to set, load or adjust the power tool. Before starting the power tool always check to make certain they have been removed and are safely away from the machine.

Prevent unintentional starting. Before plugging any machine in to the power supply, make sure the switch is in the OFF position. If the machine is portable, do not hold the machine near the switch and take care when putting the machine down, that nothing can operate the switch.

Carefully select an extension lead. Some machines are not suitable for use with extension leads. If the tool is designed for use outdoors, use an extension lead also suitable for that environment. When using an extended lead, select one capable of handling the current (amps) drawn by the machine in use. Fully extend the lead regardless of the distance between the power supply and the tool. Excess current (amps) and a coiled extension lead will both cause the cable to heat up and can result in fire.

Concentrate and stay alert. Distractions are likely to cause an accident. Never operate a power tool if you are under the influence of drugs (prescription or otherwise), including alcohol or if you are feeling tired. Being disorientated will result in an accident.

Have this tool repaired by a qualified person. This tool is designed to conform to the relevant international and local standards and as such should be maintained and repaired by someone qualified, using only original parts supplied by the manufacturer. This will ensure the tool remains safe to use.

5.2 ADDITIONAL SAFETY INSTRUCTIONS FOR HAMMER DRILL

Warnings

1. Wear ear protectors. Exposure to noise can cause hearing loss.
2. Use auxiliary handle(s), if supplied with the tool. Loss of control can cause personal injury.
3. Hold power tool by insulated gripping surfaces, when performing an operation where the cutting accessory may contact hidden wiring or its own cord. Cutting accessory contacting a "live" wire may make exposed metal parts of the power tool "live" and could give the operator an electric shock.

5. HEALTH AND SAFETY INFORMATION

5.3 RESIDUAL RISK

Important note: Although the safety instructions and operating manuals for our tools contain extensive instructions for safe working with power tools, every power tool involves a certain residual risk which can not be completely excluded by safety mechanisms. Power tools must therefore always be operated with caution!

5.4 SAFETY INSTRUCTIONS FOR MAINS POWERED CHARGERS & BATTERY PACKS

Chargers

- The charger is for indoor use only.
- Prior to plugging the charger in to the supply, check that the plug and the cable are in good repair. If either are damaged, have the defective item replaced immediately by a suitably qualified person. If the casing of the battery charger is damaged, it is good policy to have the charger checked over by a suitably qualified person.
- Only use a correctly rated mains outlet to provide power, do not plug into site generators, attach to engine generators or D.C. sources. Do not use a mains socket outlet that is not switched.
- Use the correct Draper charger in conjunction with it's corresponding battery pack (consult the Draper website for more information or to find your local stockist).
- Do not charge any other batteries with Draper chargers. Any other application is considered misuse.
- Do not attempt to charge battery packs that are too hot (over 30°C) or too cold (under 5°C), if these conditions apply set the battery pack aside to "normalise" before proceeding with the charging operation.
- Set up the charger and cable in a safe place where it won't be knocked, tripped over, stepped on, etc. and where it is well ventilated. Make sure the ventilation slots in the charger case are not obstructed, plug the charger into the socket outlet.
- Inspect the battery pack for damage, if it is undamaged, plug it into the charger, ensuring the correct orientation. (Most chargers and batteries have 'keys' etc, to make sure the battery pack is not inserted incorrectly, if you are having to 'force' the battery pack into the charger, the chances are you have it the wrong way round, check and try again.)
- Switch the charger on and check that the correct indicators illuminate, allow the battery pack to charge (see the specific instructions for your charger). Once charging is complete, switch the charger off, remove the battery pack and store, repeat the procedure if you have more than one battery pack to charge.

Caution: When the battery charger has been continuously used, the battery charger will be hot. Once the charging has been completed, give 15 minutes rest until the next charge.

- After charging is complete, unplug the charger from the socket outlet by pulling on the plug. Do not pull on the cable. Store the charger in a dry secure place.
- If, when the charger was switched on, the correct indications did not occur, leave for two or three minutes to allow the charger to stabilise, if the correct indications occur, allow the charging cycle to proceed as normal. If no indication appears at all, switch off, remove the battery pack, unplug the charger, check that the charger contacts and the battery contacts are clean and repeat the process. If there is still no indication, switch off, remove the battery pack, unplug the charger and check the fuse. If the fuse is blown, replace and repeat the process. If the fuse blows again, or if the fuse was intact, attempt no further action. Refer the charger to a suitably qualified person for repair.

5. HEALTH AND SAFETY INFORMATION

Battery packs

- Before charging, read the instructions.
- For indoor use. Do not expose to rain.
- Only use Draper D20 battery packs with this product. Consult your Draper stockist for details.
- Do not charge any other manufacturer's battery packs using Draper chargers. Any other application is considered misuse.
- The battery must be removed from the appliance before it is recycled.
- The charger must be disconnected from the supply mains when removing the battery.
- The battery is to be disposed of in-line with local authority procedures.
- Do not use any other than the designated Draper batteries/chargers with this product.
- Do not crush, open or burn the battery. Exposure to potentially harmful materials may occur.
- In case of fire use CO₂ or dry chemical extinguisher.
- Do not expose to high temperatures >50°C. The battery may degrade at high temperatures.
- Charge battery in conditions between 5°C to 30°C with the specified charger designed for this battery.
- Do not use battery if it has been stored at 5°C or less. Allow it to “normalise” at room temperature before usage/charging.

Warning!

- Leaking battery packs
 - The electrolyte in battery packs is corrosive. Avoid contact with the skin.
 - If contact is made, flush the area with running water, pat dry and seek medical attention and advice at the earliest opportunity.
 - Inform medical personnel that the contaminant is a “high alkaline, corrosive liquid”.
 - If electrolyte comes into contact with the eyes, flush with copious amounts of water only. Seek medical attention immediately, relaying the information above.

5.5 CONNECTION TO THE POWER SUPPLY (CHARGER)

Caution: Risk of electric shock. Do not open.

This appliance is supplied with a moulded 3 pin mains plug for your safety. The value of the fuse fitted is marked on the pin face of the plug. Should the fuse need replacing, ensure the substitute is of the correct rating, approved to BS1362 and ASTA or BSI Kite marked.

ASTA 

BSI 

The fuse cover is removable with a small plain slot screwdriver. Ensure the fuse cover is replaced before attempting to connect the plug to an electrical outlet. If the cover is missing, a replacement must be obtained or the plug replaced with a suitable type.

If a replacement plug is to be fitted this must be carried out by a qualified electrician.

The damaged or incomplete plug, when cut from the cable should be disabled to prevent connection to a live electrical outlet.

This appliance is Class II[†] and is designed for connection to a power supply matching that detailed on the rating label and compatible with the plug fitted.

If an extension lead is required, use an approved and compatible lead rated for this appliance. Follow all the instructions supplied with the extension lead.

[†]*Double insulated* : This product requires no earth connection as supplementary insulation is applied to the basic insulation to protect against electric shock in the event of failure of the basic insulation.

IMPORTANT

If using an extension lead, follow the instructions that came with your lead regarding maximum load while cable is wound. If in doubt, ensure that the entire cable is unwound. Using a coiled extension lead will generate heat which could melt the lead and cause a fire.

6. TECHNICAL DESCRIPTION

6.1 IDENTIFICATION



- ① 2 Speed selector switch.
- ② Function selector.
- ③ 13mm Keyless chuck.
- ④ Torque selection collar.
- ⑤ LED Worklight.
- ⑥ Variable speed trigger switch.
- ⑦ Forward/reverse selector.
- ⑧ Hand grip.

7. UNPACKING AND CHECKING

7.1 PACKAGING

Carefully remove the product from the packaging and examine it for any sign of damage that may have happened during shipping. Lay the contents out and check them against the parts shown below. If any part is damaged or missing, please contact the Draper Help Line (the telephone number appears on the Title page) and do not attempt to use the product.

The packaging material should be retained at least during the warranty period, in case the machine needs to be returned for repair.

Warning!

- Some of the packaging materials used may be harmful to children. Do not leave any of these materials in the reach of children.
- If any of the packaging is to be thrown away, make sure they are disposed of correctly, according to local regulations.

7.2 D20 MULTI-TOOL INTERCHANGEABLE BATTERY SYSTEM

The D20 range of tools are a range of tools suitable for enthusiasts and tradespersons alike, featuring a wide array of machines all running from the same range of batteries. Many different capacity batteries are available making sure you can balance tool weight with longevity and find a battery that meets your needs. To find out the latest range of accessories including batteries and chargers please consult the Draper website for more information or to find your local Draper stockist.



7.3 WHAT'S IN THE BOX

As well as the hammer drill, there are several parts not fitted or attached to it.

- ⑨ 1 x 4.0Ah Li-ion battery.
- ⑩ Auxiliary handle.
- ⑪ D20 fast charger.
- ⑫ Belt clip.

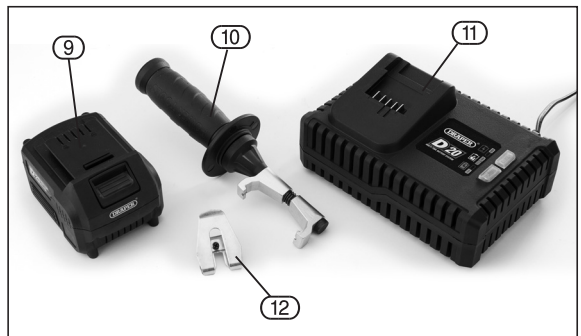

8. PREPARING THE DRILL

8.1 BATTERY PACK CHARGING – FIGS. 1 – 2

This power product is either supplied “bare”, without battery pack or charger (Stock No.55519), or with a transformer/charger and one battery pack (Stock No.00594).

Important: Only Draper designated battery packs and chargers can be used in conjunction with this product. Use of any other third party battery packs/chargers with this product is considered misuse and will invalidate the product’s warranty.

Once connected to the mains supply, recharging of the battery can be left generally unsupervised, requiring minimal attention. Complex circuit construction monitors the battery condition, adjusting the recharge current to suit. When the recharge cycle is complete, to maintain the full capacity, a low output current will continue as required.

Warning! Check the condition of the charger and battery prior to each charge. If there is any sign of damage then do not commence charging, seek advice from Draper Tools.

The battery pack is supplied un-charged and must be charged before initial use.

To charge the battery pack (9), it must first be removed from the tool.

To release the battery pack:

- Press the battery release button (9.1) and gently slide the battery pack off (Fig.1).
- Plug the battery charger (11) unit into a 230V/AC 13amp three pin supply socket.
- The red LED (11.1) will illuminate to show the charger has power.
- Slide the battery into the charger (the battery is shaped to fit into the charger one way only).
- After a few seconds delay, the red LED (11.1) will flash to show that charging has begun, then illuminate solid red.
- Whilst the battery is charging, the green LED (11.2) will flash, (the red LED will go from flashing to constant red).
- When the battery is fully charged when the green LED stops flashing and remains a constant green. The red LED will extinguish.

Caution: Do not pull the plug out of the power supply by pulling on the cord. Make sure to grasp the plug when removing from power supply to avoid damaging the cord.

To remove the battery from the battery charger:

- Supporting the battery charger with hand, pull out the battery from the battery charger.

Caution: If the battery charger has been in continuous use it will be hot. Once the charging has been completed, leave the charger 15 minutes to cool until next use.

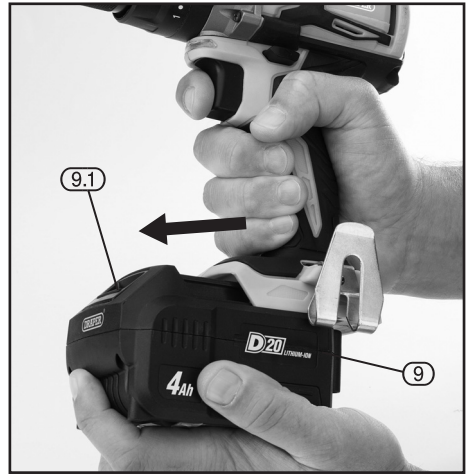

FIG.1



FIG.2

8. PREPARING THE DRILL

If the battery is charged when it is warm due to battery use or exposure to sunlight, the battery will not be recharged. In such a case, let the battery cool before charging.

If the red indicator flickers rapidly at 0.2 second intervals, check or and remove any foreign objects in the charger's battery slot. If there are no foreign objects, it is probable that the battery or charger is malfunctioning. Allow battery/charger to normalise and try again. If a fault remains after trying this then contact Draper Tools.

8.2 BATTERY PACK PROTECTION FEATURES

Overcharging protection: This feature that ensures that the battery pack can never be overcharged. When the battery pack reaches full charge capacity, the transformer/charger will automatically shut off, protecting the internal components from being damaged.

Over-discharging protection: This feature will stop the battery pack from discharging beyond the recommended lowest safety voltage.

Overheating protection: The battery pack contains an internal thermistor cut-off sensor which shuts off the battery pack should it become too hot during operation. This can happen if the tool is overloaded or being used for extended periods. Up to 30 minutes cooling time may be required, depending on ambient temperature.

Current protection: Should the battery be overloaded and the maximum current draw be exceeded, the battery will shut off to protect the internal components. The battery pack will resume working once excessive current draw has returned to normal, safe level.

Short circuit protection: If, for any reason, the battery pack was to short circuit, the short circuit protection would immediately stop the battery pack from operating.

8.3 BATTERY PACK CHARGE STATUS – FIG. 3

To display the amount of charge left in the battery pack, press the charge level indicator button (9.2).

8.4 BATTERY LIFE EFFICIENCY AND CHARGING ADVICE

- Avoid recharging at high temperatures.
A rechargeable battery will be hot immediately after use. If such a battery is recharged immediately after use, its internal chemical substance will deteriorate, and the battery life will be shortened. Leave the battery and recharge it after it has cooled for a while.
- The battery should only be used and/or charged when battery temperature is between 5°C and 30°C.
- The battery needs to be warmed-up or cooled down in order to prevent damage to the batteries internal components,

Note: If battery is too hot or too cold, allow it to 'normalise' before use or charging.

Note: Failure to warm up or cool down a battery could result in serious damage to the battery, charger and user.



Charge level indicator	Amount of charge remaining
	0 – 10%
	10 – 25%
	25 – 50%
	50 – 75%
	75 – 100%

FIG.3

9. BASIC HAMMER DRILL OPERATIONS

Warning!

- Dust and swarf
 - A correctly fitted dust mask, suitable for the activity and in accordance to the relevant standard must be worn.
- Swarf produced by metal drilling is extremely sharp. Take precautions when clearing swarf. The burr left on the hole is also sharp and should be removed with a suitable tool.
- Always wear safety goggles.
- Drill bit will be hot after use.

9.1 INSTALLING AND REMOVING BITS – FIG. 1

Note: This product is equipped with an electric brake.

The drill is fitted with a keyless chuck, this means that a chuck key is not required to secure the drill or screwdriver bit.

- Place the drill bit shoulder into the chuck as far as it will go, making sure not to grip by the “flute”.
- Tighten the chuck firmly.

Note: Short screwdriver bits need only be inserted to the depth of the hexagon shank before tightening chuck by hand.



FIG.1



FIG.2

9.2 ROTATIONAL DRIVE SELECTION – FIG.2

The forward/reverse drive selector switch (7) determines the direction of rotation of the drive, i.e. clockwise or anticlockwise.

To alter the direction of rotation:

- Stop the machine and push switch (7) to the left or right.
- When the direction switch is pushed to the left, the drive will rotate clockwise.
- When the switch is pushed to the right, the drive will rotate anticlockwise.
- Before operation, check that the switch is set in the required position. Do not change the direction of rotation until the driver comes to a complete stop.
- When the driver is not in use move the direction switch to the neutral position (the middle setting) to lock the trigger out.

Note: Failure to use the neutral position may activate the trigger inadvertently. This inadvertent operation may cause the driver to become damaged.

9. BASIC HAMMER DRILL OPERATIONS

9.3 VARIABLE SPEED TRIGGER – FIG.3

When the trigger (6) is depressed, the drive will rotate (provided the direction switch (7) is set in the forward or reverse position). This trigger switch is electronic which enables the user to vary the speed continuously.

- The speed varies according to how far the trigger switch is depressed.
- The further it is depressed, the faster the drive spindle will rotate.
- The lighter it is depressed, the slower it will rotate.

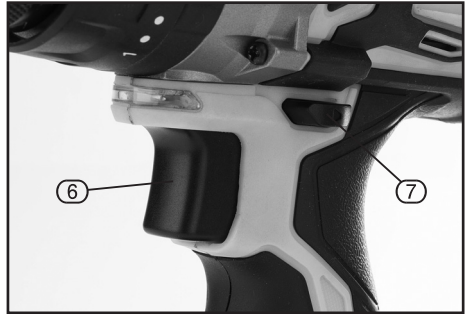





FIG.3

9.4 TORQUE SELECTION CONTROL – FIG.4

By turning the collar (4) it is possible to adjust the amount of torque.

- Settings 1 – 20 provide a facility for setting the torque to the required level. For example, this means that repetitive driving of screws of the same size will be driven into the material to the same torque, thus giving the same fixing strength, or in the case of countersunk screws, these will all be driven to the same depth in the material.
- The torque control prevents the heads of small diameter screws being twisted off when correctly set.
- By turning the selector (2) it is possible to switch between rotary drilling, percussion drilling and screwdriving functions:
- Twist the torque setting to  for rotary drilling.
- For the “hammer drill” setting, twist the torque setting to  and the percussion feature will come into action – this is intended for drilling into masonry, etc.
- Twist the torque setting to  for screwdriving functions.

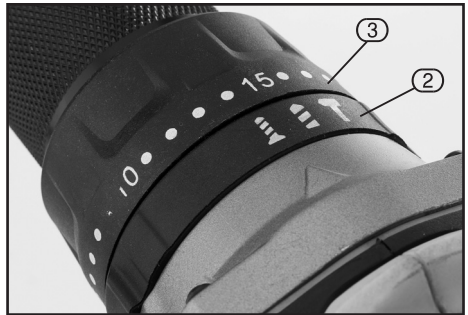

FIG.4

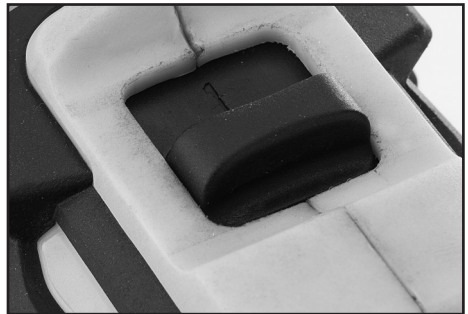

FIG.5

9.5 TWO SPEED GEAR BOX – FIG.5

- Select a low gear 1 (slower rotational speed and higher torque) for screwdriving.
- Use a high gear 2 (faster rotational speed and lower torque) for drilling holes.

9. BASIC HAMMER DRILL OPERATIONS

9.6 BELT CLIP – FIG.6

The spring steel belt clip (12) is convenient for hanging the drill temporarily. The clip can be installed on either side of the tool.

To install the clip:

- Locate the clip (12) in position and fasten with screw (12.1) supplied, take care to not overtighten and strip the thread.

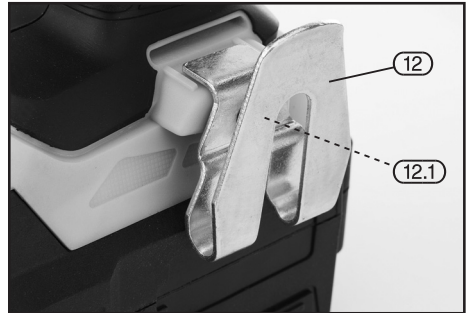

FIG.6

9.7 LED WORKLIGHT – FIG.7

To aid use in confined, and inadequately lit spaces; the LED worklight (5) automatically illuminates when the trigger is activated.

9.8 AUXILIARY HAND GRIP – FIG.8

Warning!

- Use the auxiliary handle (9) supplied with the tool. Loss of control has the potential to cause personal injury..

The power tool features left and right hand auxiliary handle mountings of each side of the tool.

- Simply screw the auxiliary handle clockwise into the chosen mounting (9.1) on either side of the drill.

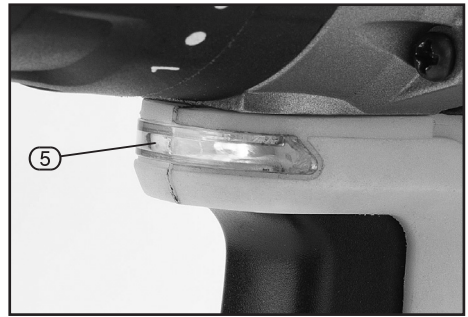

FIG.7

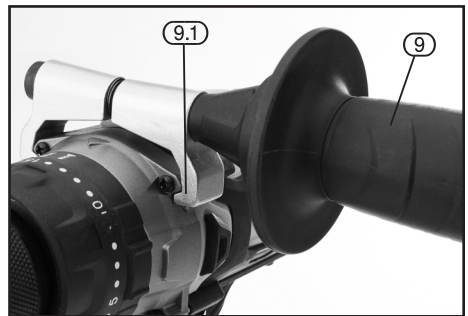

FIG.8

9. BASIC HAMMER DRILL OPERATIONS

9.9 SCREWDRIVING

To prevent slip or damage to the screw head, match the screwdriver bit to the screw head size.

To remove screws:

- Move the direction switch to the reversing position and apply pressure to the screw head and depress the trigger slowly).

Screwdriver bits are consumable items.

9.10 DRILLING WOOD AND PLASTIC – FIG. 9

To prevent splitting around the drill holes on the reverse side, clamp a piece of scrap timber **A** under the material to be drilled.

9.11 DRILLING METAL – FIG.10

Metals such as mild steel, aluminium and brass may be drilled.

- Mark the point to be drilled with a centre punch **B** to help the drill bit tip to locate.
- A drop of oil **C** on the drilled area will aid cutting and help prolong the life of the bit.

Note: Although metal drilling is technically within the capabilities of this drill, its rotational speed is not always fast enough to achieve perfect results every time. For this reason, extra caution should always be taken when drilling metal, as snagging of the drill may occur.

9.12 DRILLING MASONRY

Start drilling at a low speed to prevent the drill bit from wandering. Once penetration is achieved, fully depress the trigger to achieve maximum speed and hammer power.

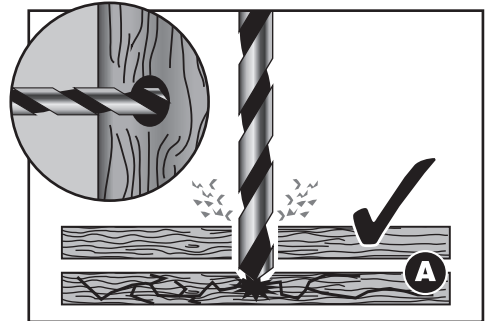

FIG.9

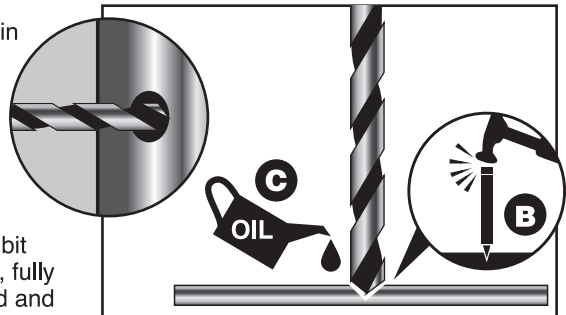

FIG.10

10. OPTIONAL ACCESSORIES

10.1 OPTIONAL ACCESSORIES

A full range of accessories are available from Draper Tools.

Please visit our website for details: www.drapertools.com

11. MAINTENANCE & TROUBLESHOOTING

11.1 MAINTENANCE

Regular inspection and cleaning reduces the necessity for maintenance operations and will keep your tool in good working condition.

The motor must be correctly ventilated during tool operation. Avoid blocking the air inlets and vacuum the ventilation slots regularly.

11.2 TROUBLESHOOTING GUIDE

Note: Remove the battery pack before carrying out adjustment, servicing or maintenance.

Problems	Possible cause	Required action
Drill does not operate.	<ul style="list-style-type: none">– Battery pack no charge.– Forward/reverse not selected.– battery pack faulty or damaged.	<ul style="list-style-type: none">– Re-charge battery pack.– Select forward/reverse.– Replace battery pack.
Motor runs, but slowly/ losing power.	<ul style="list-style-type: none">– Battery pack no charge.– Battery pack faulty or damaged.	<ul style="list-style-type: none">– Re-charge battery pack.– Replace battery pack.
Chuck does not close or grip	<ul style="list-style-type: none">– Swarf in chuck.	<ul style="list-style-type: none">– Clean inside of chuck with cleaning fluid.
Battery pack doesn't charge / non-illumination / non illumination of charger.	<ul style="list-style-type: none">– Fuse blown in charger plug.– Charger faulty.	<ul style="list-style-type: none">– Replace fuse.– Replace charger.

12. DISPOSAL

12.1 DISPOSAL

- At the end of the machine's working life, or when it can no longer be repaired, ensure that it is disposed of according to national regulations.
- Contact your local authority for details of collection schemes in your area.

In all circumstances:

- Do not dispose of power tools with domestic waste.
- Do not incinerate.
- Do not dispose of WEEE* as unsorted municipal waste.



Li-ion

* *Waste Electrical & Electronic Equipment.*

12.2 BATTERY PACK DISPOSAL INFORMATION

Warning!

- Do not put battery pack in fire or mutilate – cells may burst or release toxic materials.
- Do not short circuit cells, may cause burns.
- The battery pack must be removed from the appliance before it is scrapped.
- The battery pack is to be disposed of safely.
- Do not mutilate batteries, corrosive electrolyte will be released.
- Do not dispose of batteries or cells in a charged condition.

Expired batteries must be recycled/disposed of in accordance with the appropriate regulation or legislation. They should be returned to your local warranty agent/stockist.

13. EXPLANATION OF SYMBOLS

13.1 EXPLANATION OF SYMBOLS



Read the instruction manual.



Wear safety glasses.



Wear ear defenders.



Wear protective gloves.



Long and loose hair must be contained or securely tied back.



Do not abandon into the environment.



Keep out of the reach of children.



Warning!



Warning! Risk of crushing.



Direction of rotation.



Single value noise marking.
(Maximum declared A-Weighted sound power level in decibels).



Class II construction
(Double insulated).



WEEE –
Waste Electrical & Electronic Equipment.
Do not dispose of Waste Electrical & Electronic Equipment in with domestic rubbish.



Lithium-ion product.

Li-ion



Do not incinerate or throw onto fire.



For indoor use only.
Do not expose to rain.



Fuse.



Polarity indication.



Rated voltage.

NOTES

CONTACTS

Draper Tools Limited, Hursley Road,
Chandler's Ford, Eastleigh, Hampshire. SO53 1YF. U.K.

Helpline: (023) 8049 4344

Sales Desk: (023) 8049 4333

Internet: drapertools.com

E-mail: sales@drapertools.com

General Enquiries: (023) 8026 6355

Service/Warranty Repair Agent:

For aftersales servicing or warranty repairs, please contact the
Draper Tools Helpline for details of an agent in your local area.

YOUR DRAPER STOCKIST

TAKC1018

©Published by Draper Tools Limited.

No part of this publication may be reproduced, stored in a retrieval system or transmitted in any form or by any means, electronic, mechanical photocopying, recording or otherwise without prior permission in writing from Draper Tools Ltd.